

Neuchâtel Inverted Roof System Detail Drawings

Document Version: 001

Issue Date: October 2023



Index

Reference No.	Issue Date	Version No.	Description
INV 001	Oct 2023	Rev1	Upstand Detail Inverted Insulation Detail
INV 001C	Oct 2023	Rev1	Timber Wall Junction Detail Inverted Insulation Detail
INV 001D	Oct 2023	Rev1	Rendered Upstand Detail Warm Insulation Detail
INV 002	Oct 2023	Rev1	Torch-On Upstand Detail Inverted Insulation Detail
INV 003	Oct 2023	Rev1	Upstand Detail Inverted Insulation Detail
INV 004	Oct 2023	Rev1	Threshold Upstand Detail - Flush Cill
INV 004	Oct 2023	Rev1	Threshold Upstand Detail - Rebated Cill
INV 005	Oct 2023	Rev1	Parapet Outlet Detail Inverted Insulation Detail
INV 006	Oct 2023	Rev1	Outlet Detail Inverted Insulation Detail
INV 007	Oct 2023	Rev1	Parapet with Cap Flashing Detail Inverted Insulation Detail
INV 008	Oct 2023	Rev1	Change of Level Detail Inverted Insulation Detail
INV 009C	Oct 2023	Rev1	Typical Trimmed Edge Detail Inverted Insulation Detail
INV 010	Oct 2023	Rev1	Gutter Drip Edge Detail Inverted Insulation Detail
INV 011B	Oct 2023	Rev1	'Hockey Stick' Pipe Penetration Detail Inverted Insulation Detail



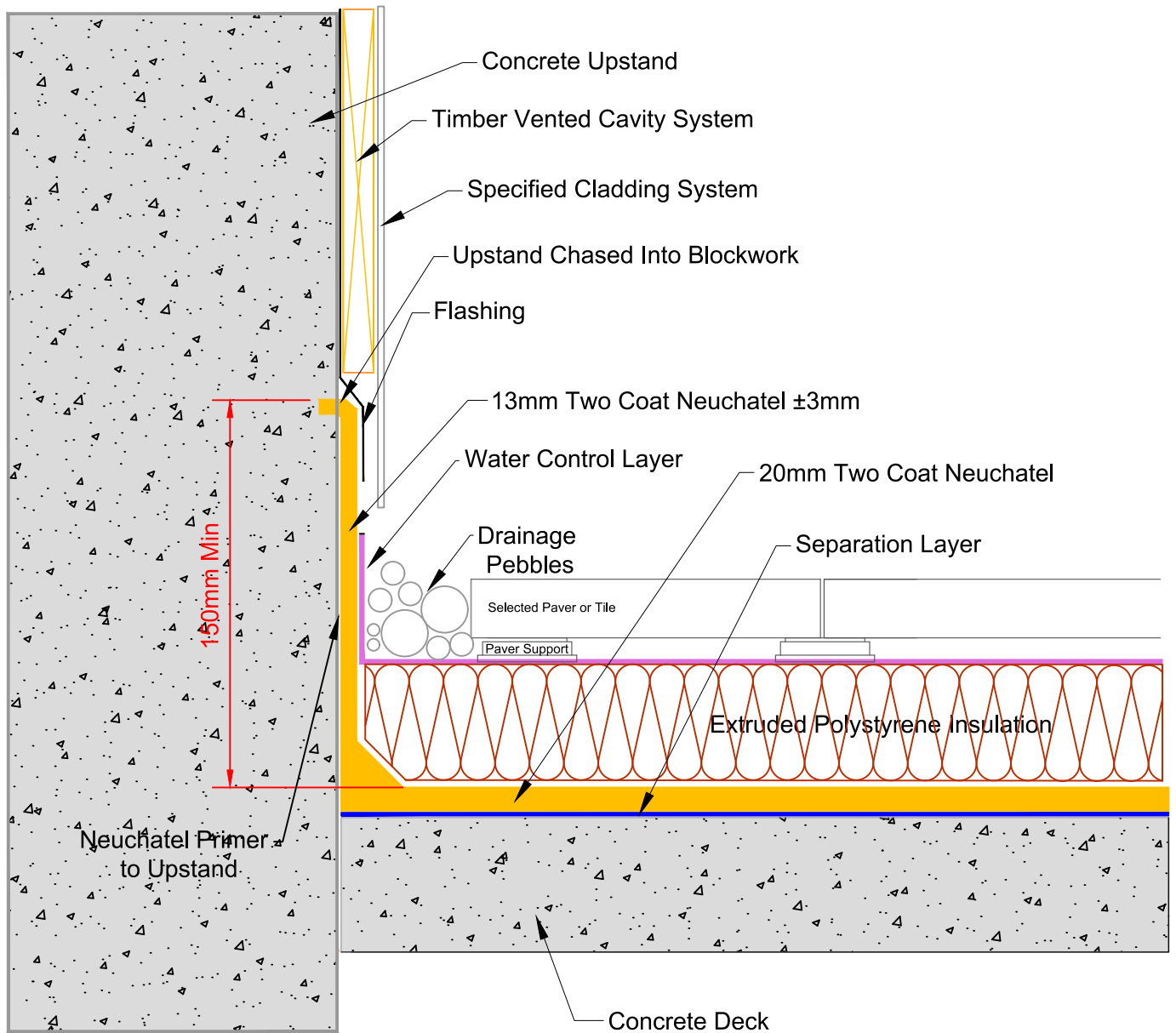

masterspec 4411AD

TITLE: **UPSTAND DETAIL
INVERTED INSULATION DETAIL**

www.neuchatel.co.nz

TECHNICAL SERVICES.
Tel: 09 441 4595
email: info@neuchatel.co.nz

Drawing: **INV 001 Rev1**

OCT 2023

Not to Scale

Drawing is indicative only and subject to approval for use in the application required.

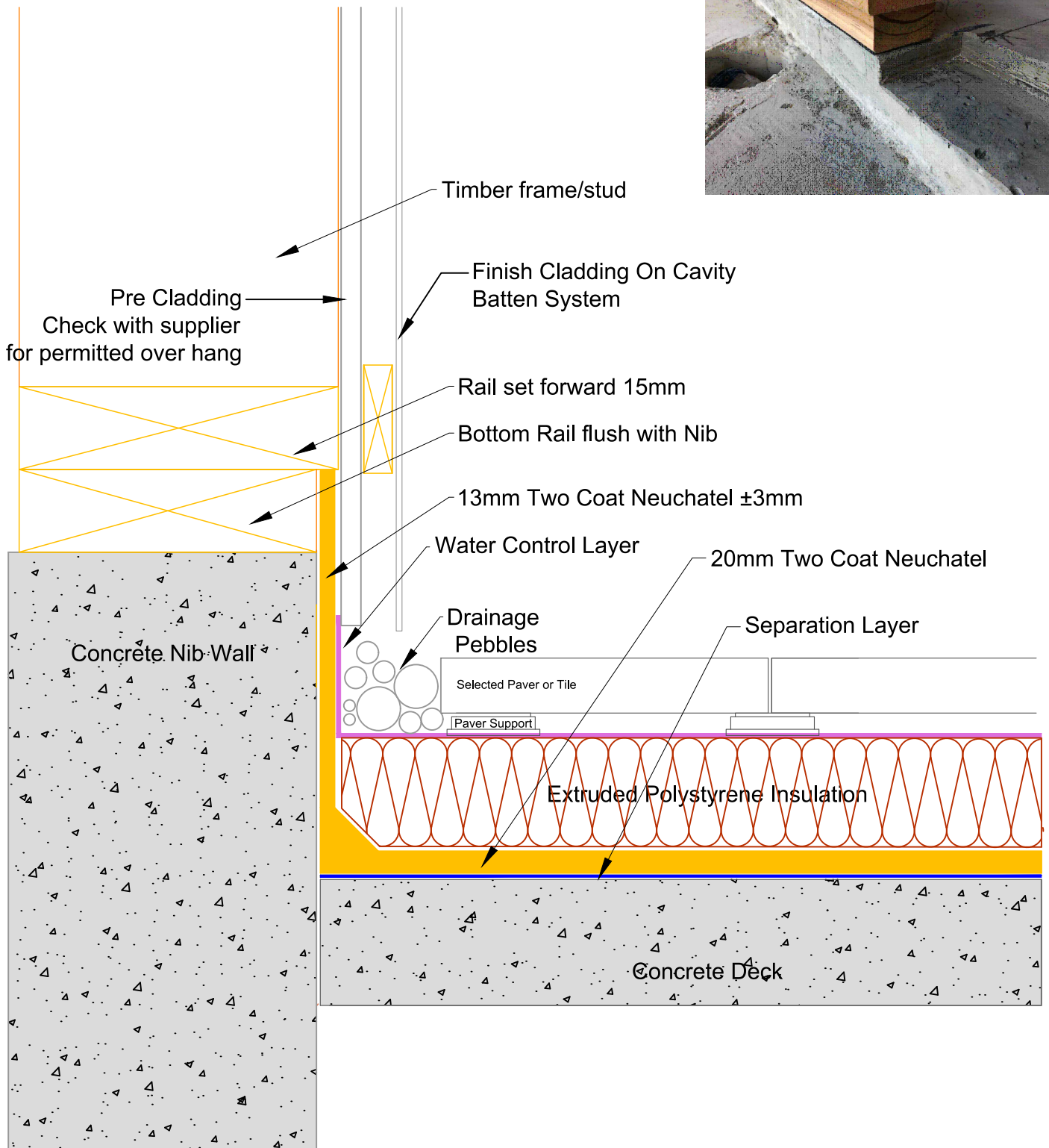

masterspec 4411AD

TITLE: **TIMBER WALL JUNCTION DETAIL
INVERTED INSULATION DETAIL**

www.neuchatel.co.nz

TECHNICAL SERVICES.
Tel: 09 441 4595
email: info@neuchatel.co.nz

Drawing: **INV 001C Rev1**

OCT 2023

Not to Scale

Drawing is indicative only and subject to approval for use in the application required.

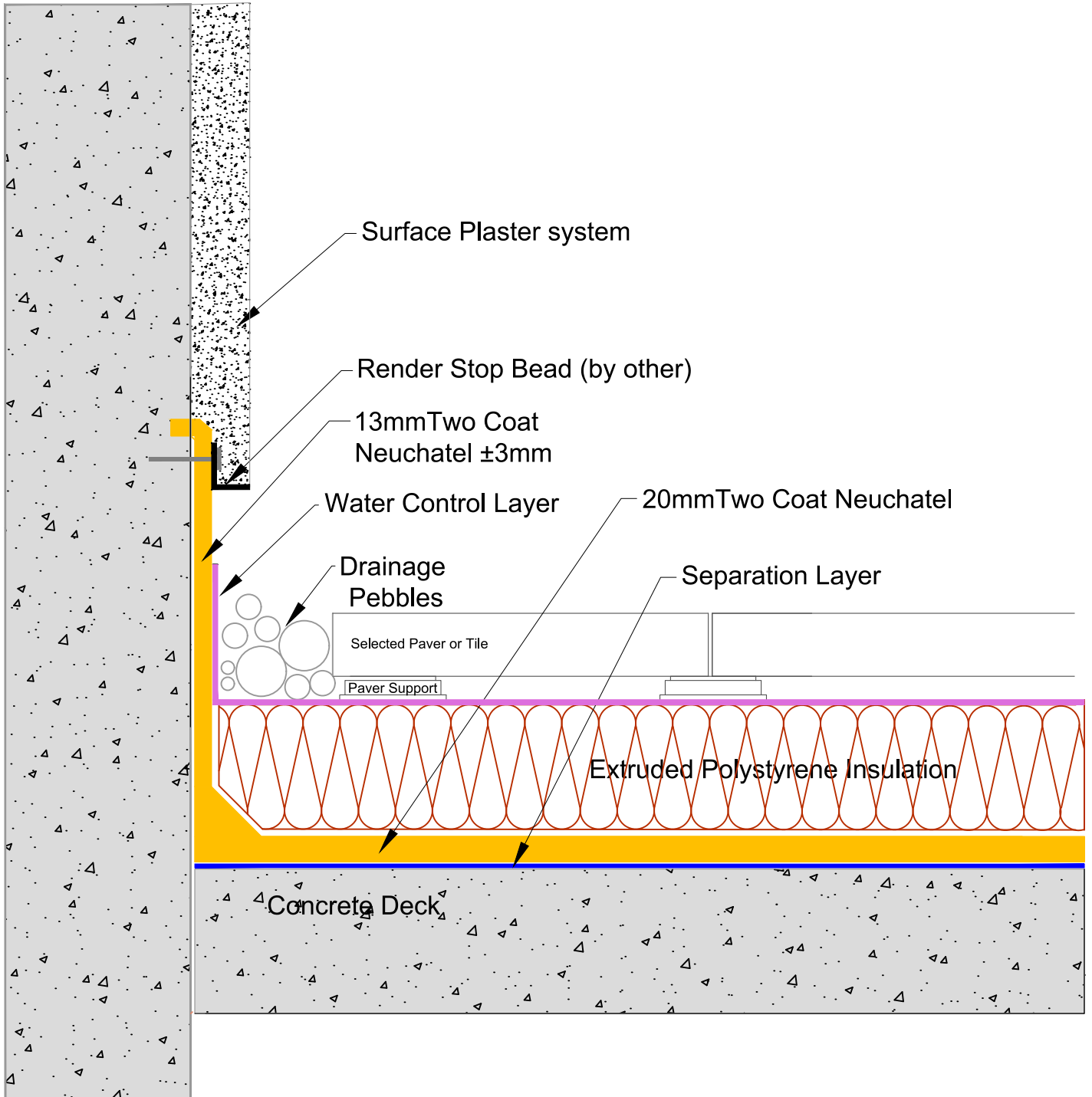

masterspec 4411AD

<p>TITLE: RENDERED UPSTAND DETAIL INVERTED INSULATION DETAIL</p>		<p>www.neuchatel.co.nz TECHNICAL SERVICES. Tel: 09 441 4595 email: info@neuchatel.co.nz</p>
<p>Drawing: INV 001D Rev1</p>	<p>OCT 2023 Not to Scale</p>	<p>Drawing is indicative only and subject to approval for use in the application required.</p>

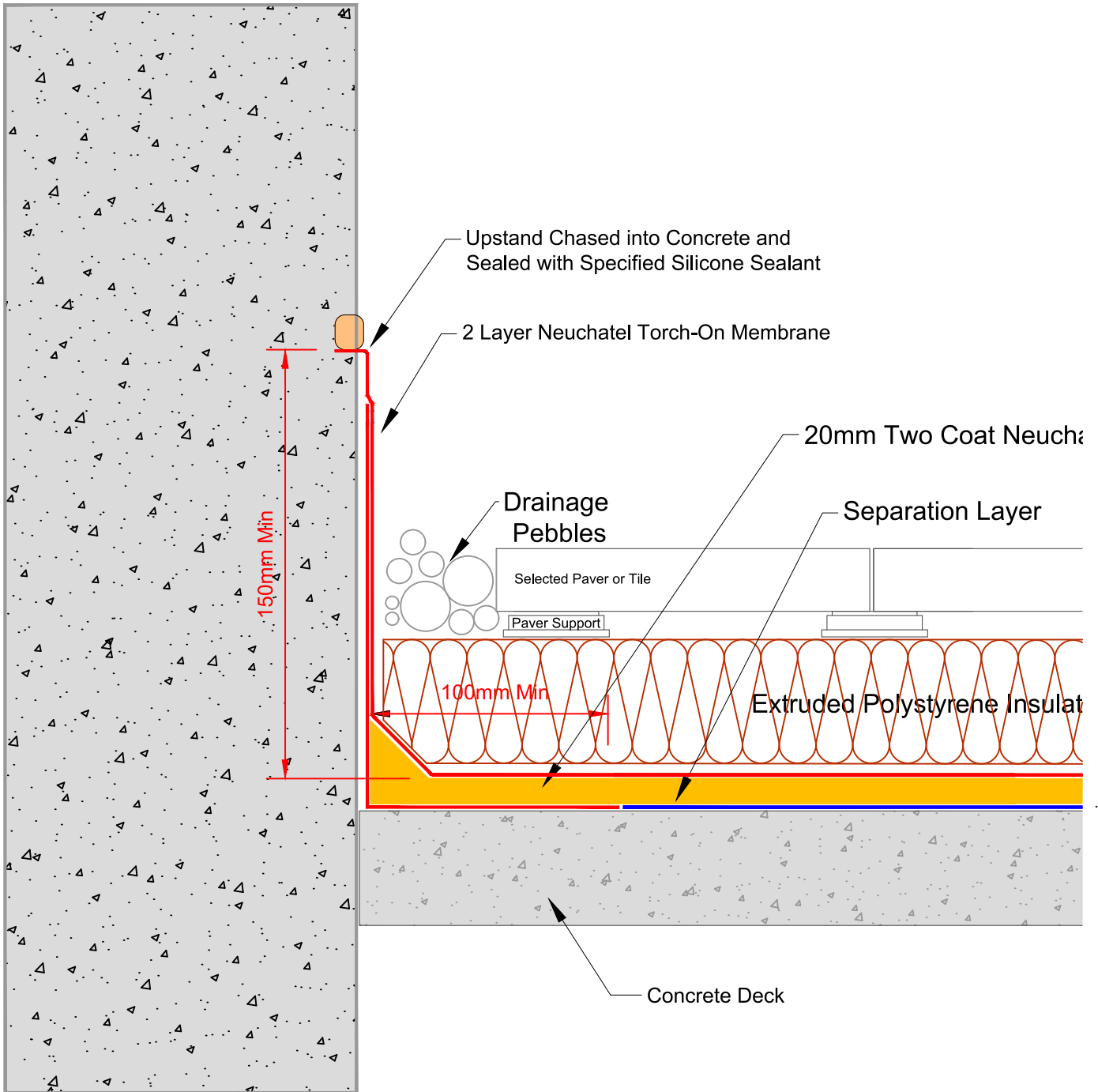

masterspec 4411AD

TITLE: TORCH-ON UPSTAND DETAIL
INVERTED INSULATION DETAIL

www.neuchatel.co.nz

TECHNICAL SERVICES.
Tel: 09 441 4595
email: info@neuchatel.co.nz

Drawing: INV 002 Rev1

OCT 2023

Not to Scale

Drawing is indicative only and subject to approval for use in the application required.

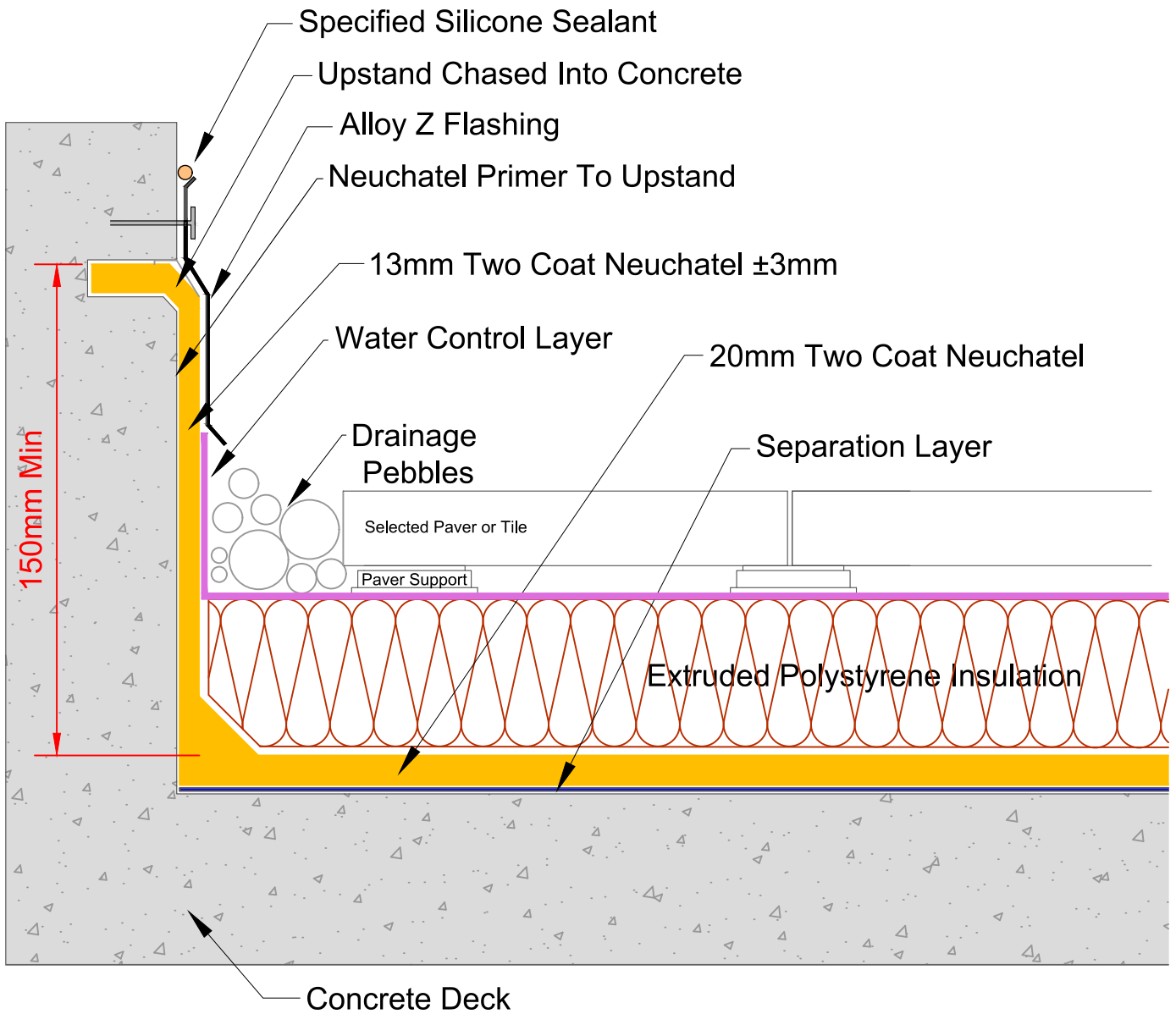

masterspec 4411AD

TITLE: UPSTAND DETAIL INVERTED INSULATION DETAIL		<p>www.neuchatel.co.nz TECHNICAL SERVICES. Tel: 09 441 4595 email: info@neuchatel.co.nz</p>
Drawing: INV 003 Rev1	OCT 2023	
	Not to Scale	Drawing is indicative only and subject to approval for use in the application required.

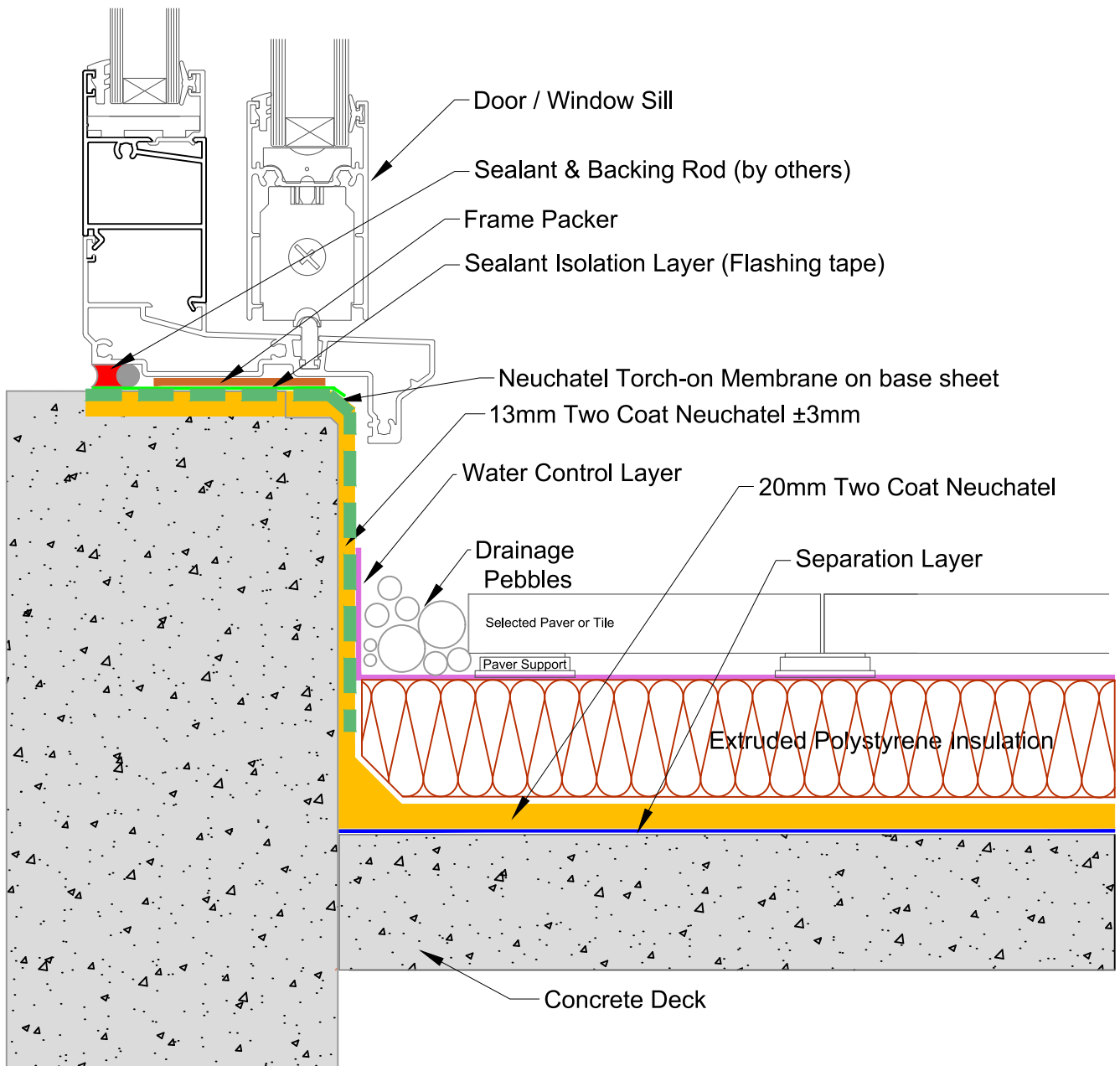

masterspec 4411AD

TITLE: THRESHOLD UPSTAND DETAIL - FLUSH CILL INVERTED INSULATION DETAIL		www.neuchatel.co.nz TECHNICAL SERVICES. Tel: 09 441 4595 email: info@neuchatel.co.nz
Drawing: INV 004 Rev1	OCT 2023 Not to Scale	Drawing is indicative only and subject to approval for use in the application required.

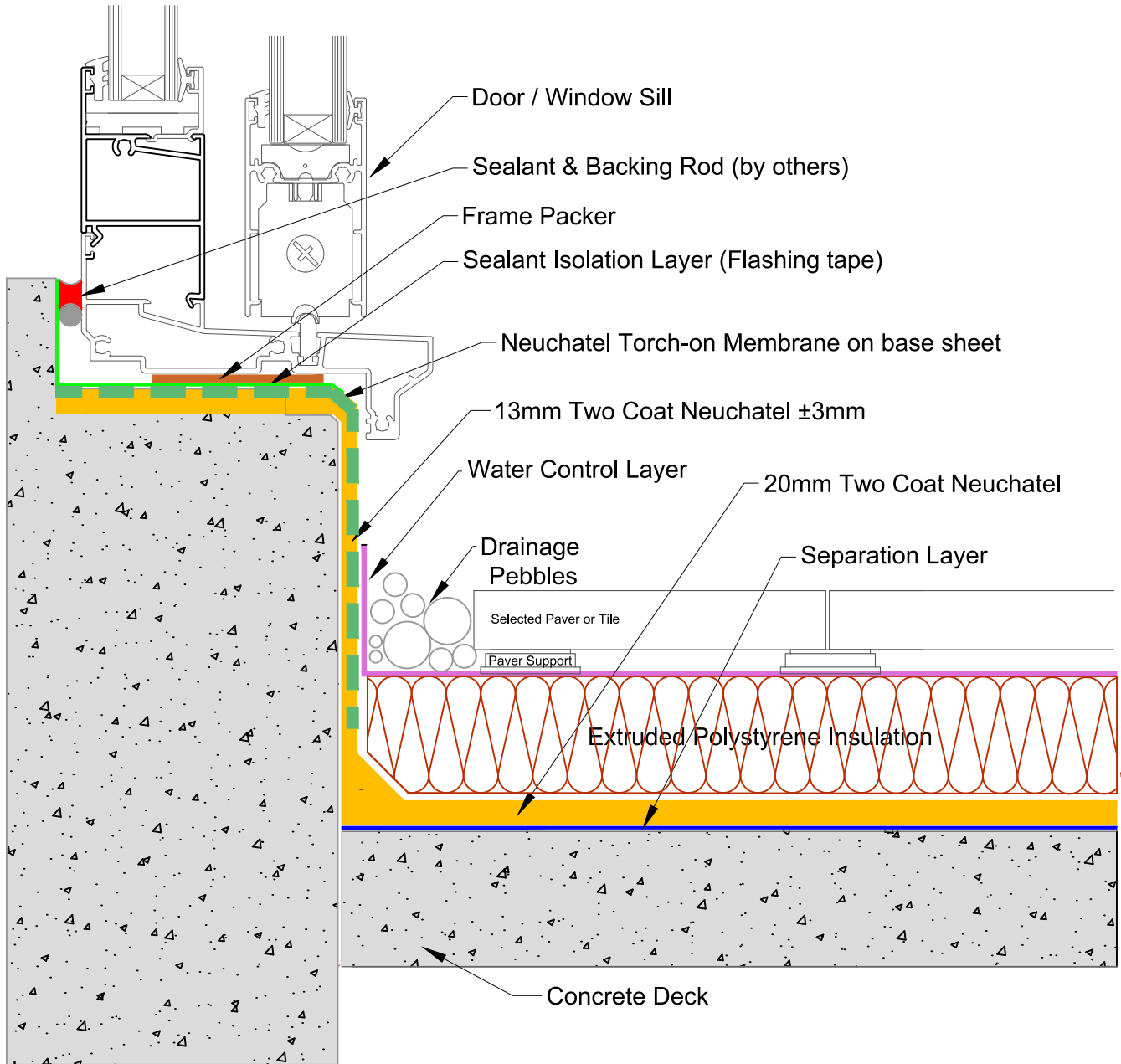

masterspec 4411AD

TITLE: **THRESHOLD UPSTAND DETAIL - REBATED CILL
INVERTED INSULATION DETAIL**

www.neuchatel.co.nz

TECHNICAL SERVICES.
Tel: 09 441 4595
email: info@neuchatel.co.nz

Drawing: **INV 004 Rev1**

OCT 2023

Not to Scale

Drawing is indicative only and subject to approval for use in the application required.

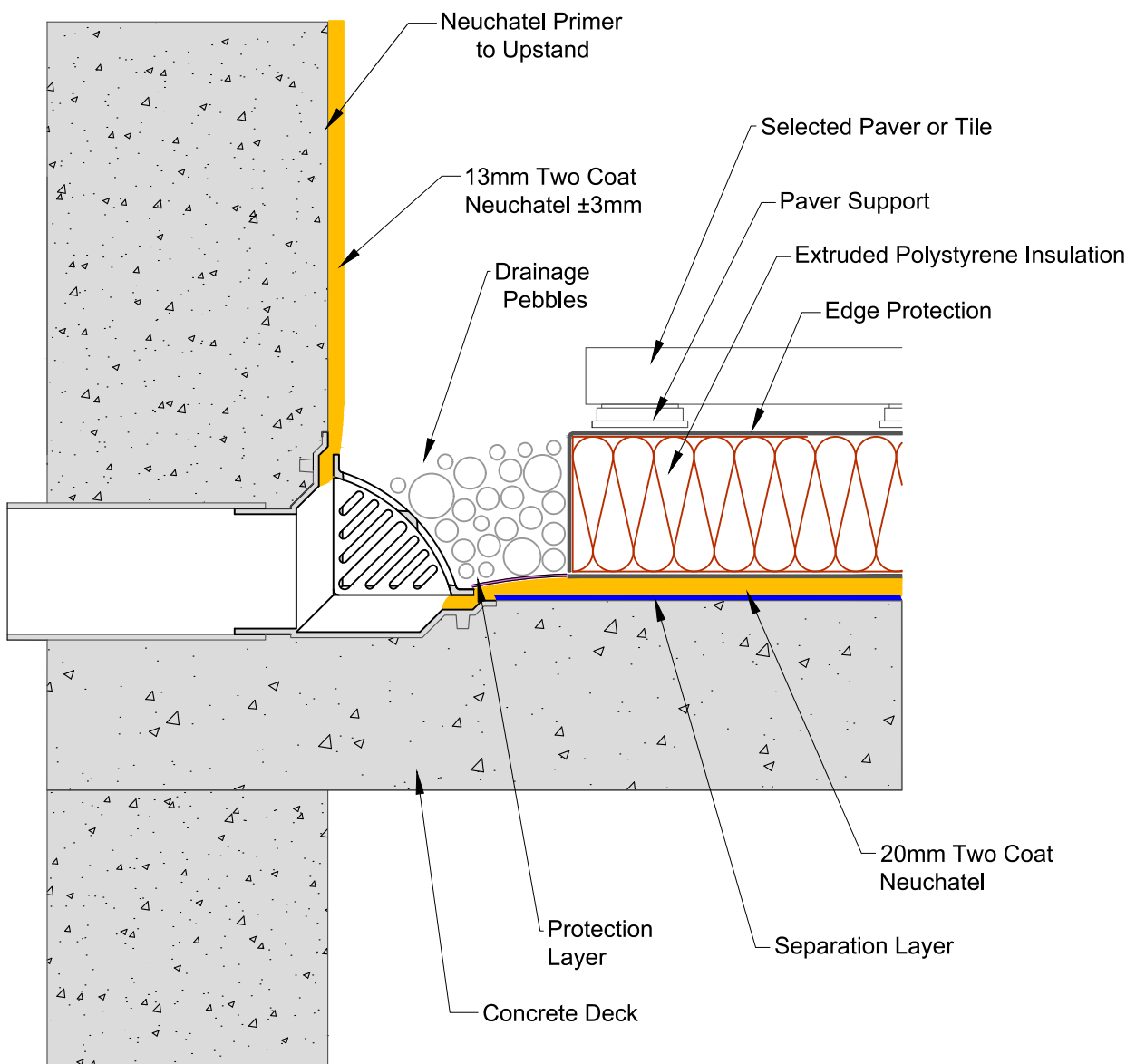

masterspec 4411AD

<p>TITLE: PARAPET OUTLET DETAIL INVERTED INSULATION DETAIL</p>	<p>www.neuchatel.co.nz TECHNICAL SERVICES. Tel: 09 441 4595 email: info@neuchatel.co.nz</p>	
<p>Drawing: INV 005 Rev1</p>	<p>OCT 2023 Not to Scale</p>	<p>Drawing is indicative only and subject to approval for use in the application required.</p>

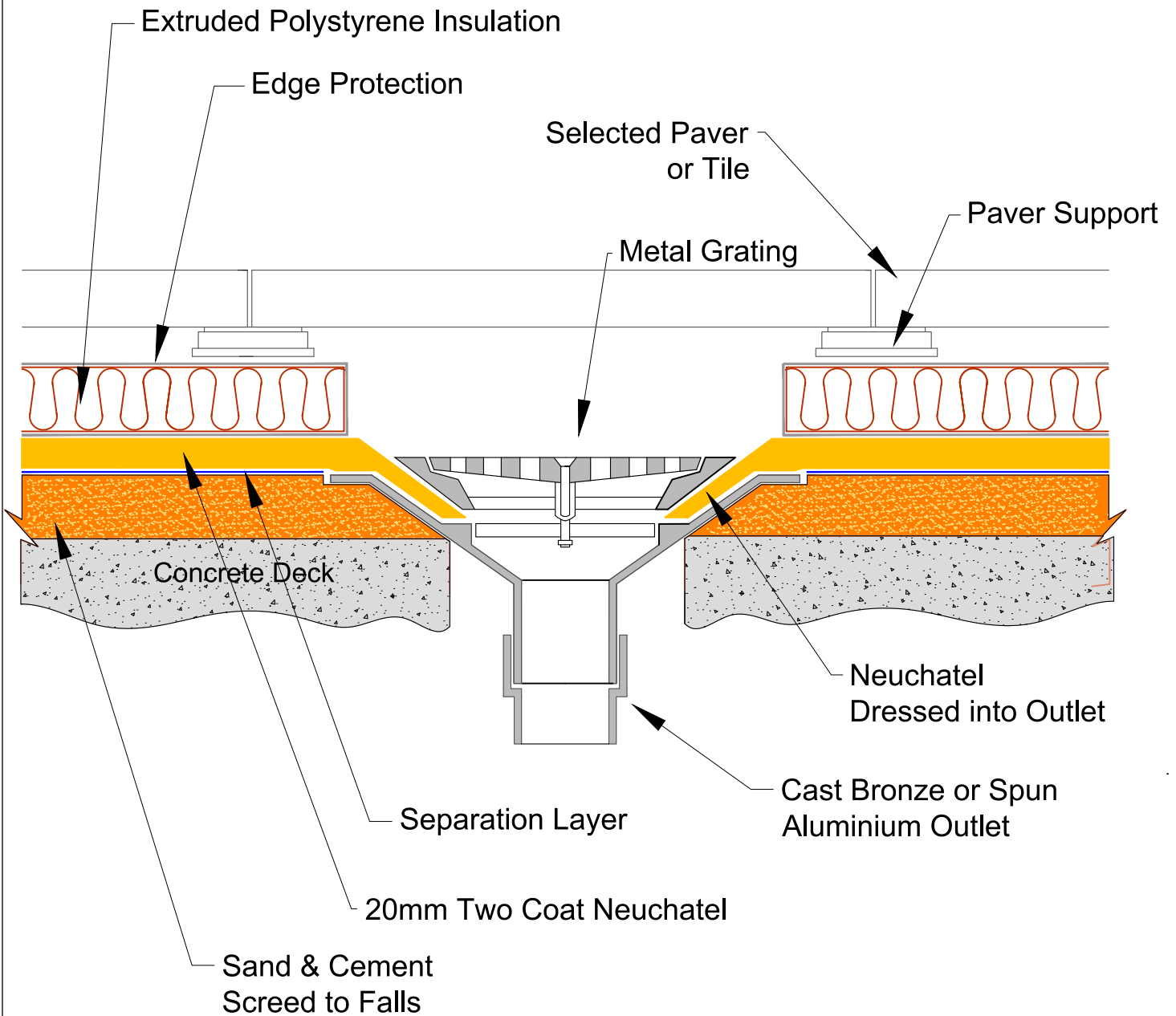

masterspec 4411AD

TITLE: OUTLET DETAIL	
INVERTED INSULATION DETAIL	
Drawing: INV 006 Rev1	OCT 2023
	Not to Scale

www.neuchatel.co.nz
 TECHNICAL SERVICES.
 Tel: 09 441 4595
 email: info@neuchatel.co.nz

Drawing is indicative only and subject to approval for use in the application required.

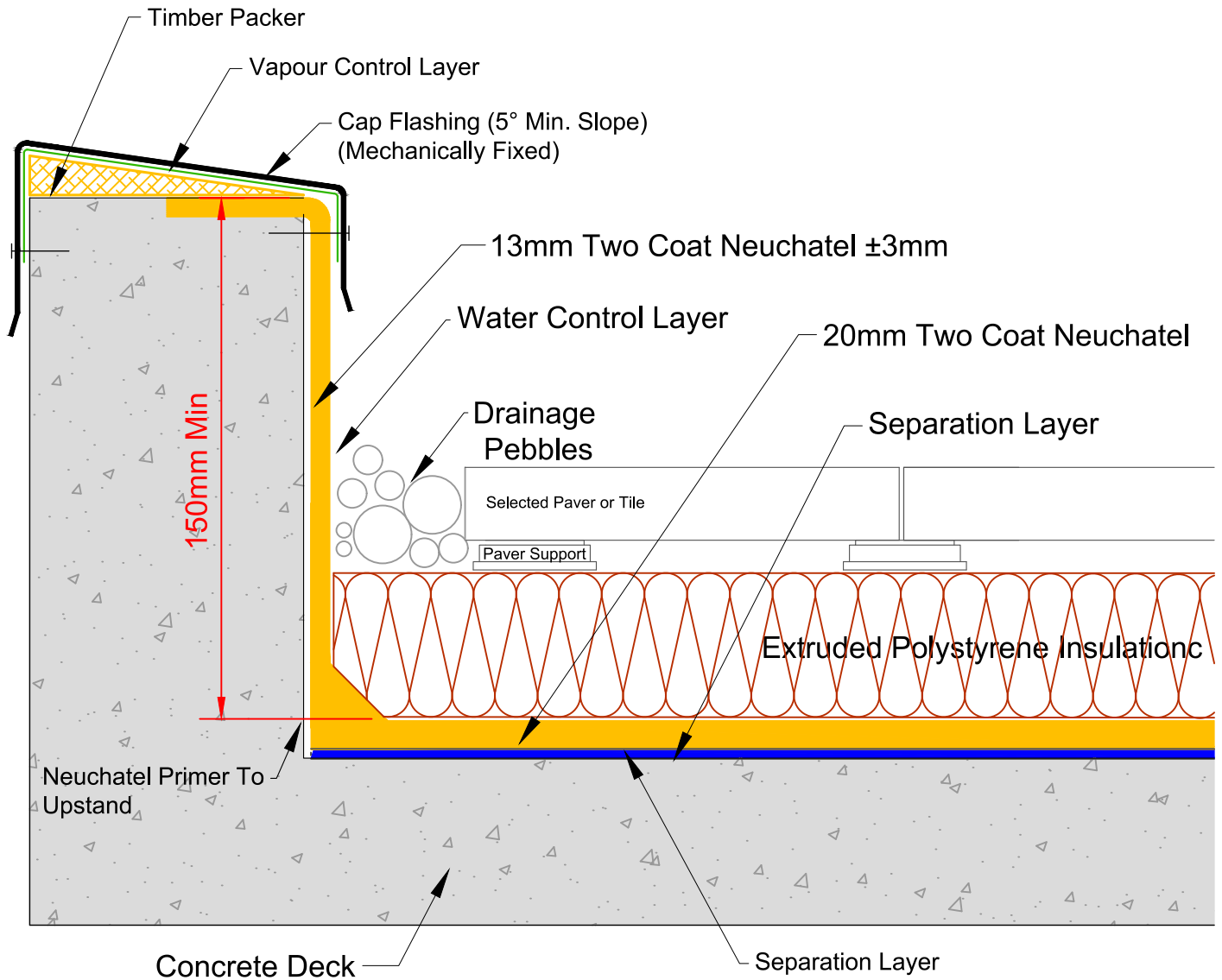

masterspec 4411AD

TITLE: PARAPET WITH CAP FLASHING DETAIL INVERTED INSULATION DETAIL		www.neuchatel.co.nz TECHNICAL SERVICES. Tel: 09 441 4595 email: info@neuchatel.co.nz
Drawing: INV 007 Rev1	OCT 2023 Not to Scale	Drawing is indicative only and subject to approval for use in the application required.

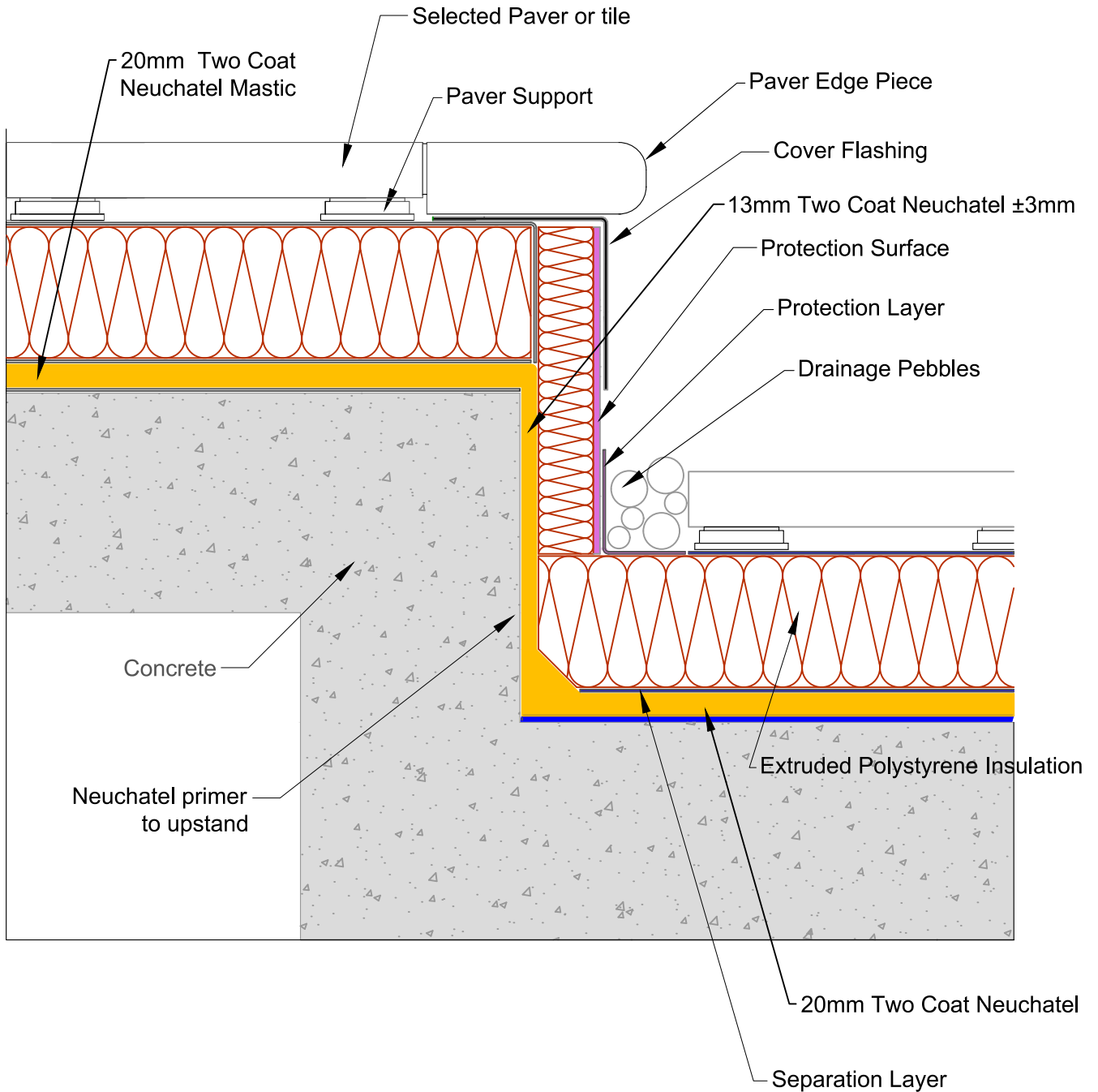

masterspec 4411AD

TITLE: **CHANGE OF LEVEL DETAIL
INVERTED INSULATION DETAIL**

www.neuchatel.co.nz

TECHNICAL SERVICES.
Tel: 09 441 4595
email: info@neuchatel.co.nz

Drawing: **INV 008 Rev1**

OCT 2023

Not to Scale

Drawing is indicative only and subject to approval for use in the application required.

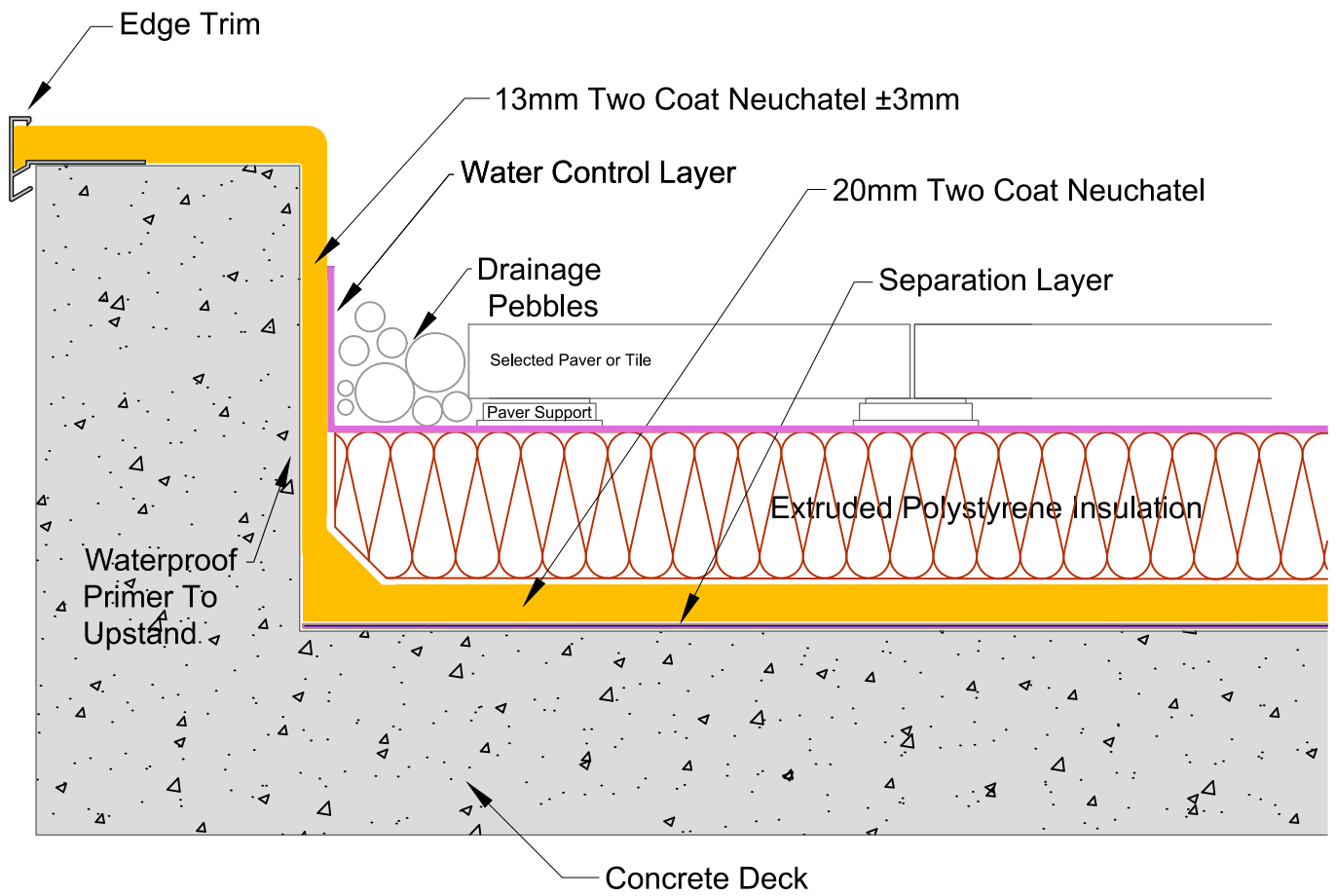

masterspec 4411AD

TITLE: TYPICAL TRIMMED EDGE DETAIL
INVERTED INSULATION DETAIL

www.neuchatel.co.nz
TECHNICAL SERVICES.
Tel: 09 441 4595
email: info@neuchatel.co.nz

Drawing: INV 009C Rev1

OCT 2023

Not to Scale

Drawing is indicative only and subject to approval for use in the application required.

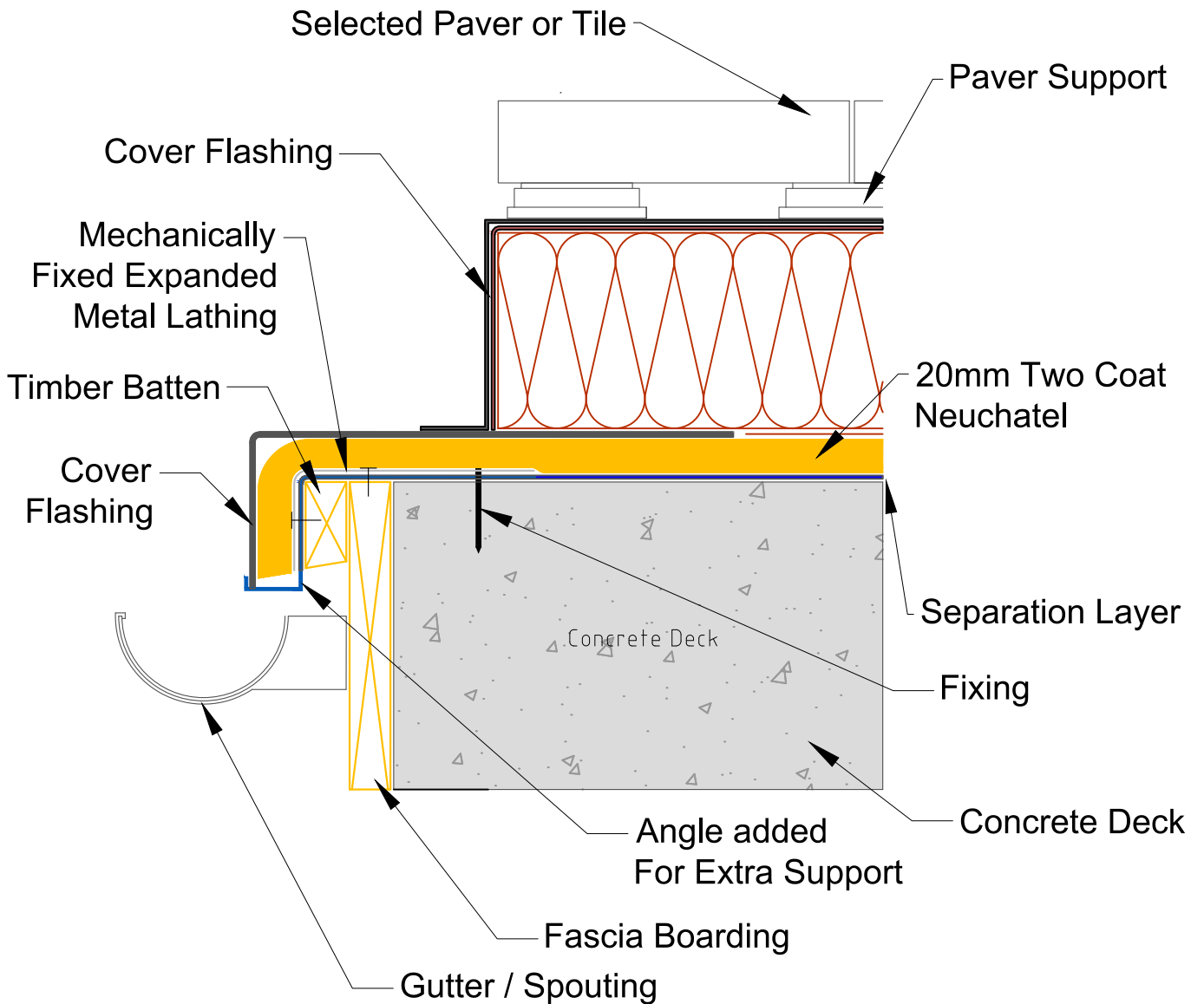

masterspec 4411AD

TITLE: GUTTER DRIP EDGE DETAIL INVERTED INSULATION DETAIL		www.neuchatel.co.nz TECHNICAL SERVICES. Tel: 09 441 4595 email: info@neuchatel.co.nz
Drawing: INV 010 Rev1	OCT 2023 Not to Scale	Drawing is indicative only and subject to approval for use in the application required.

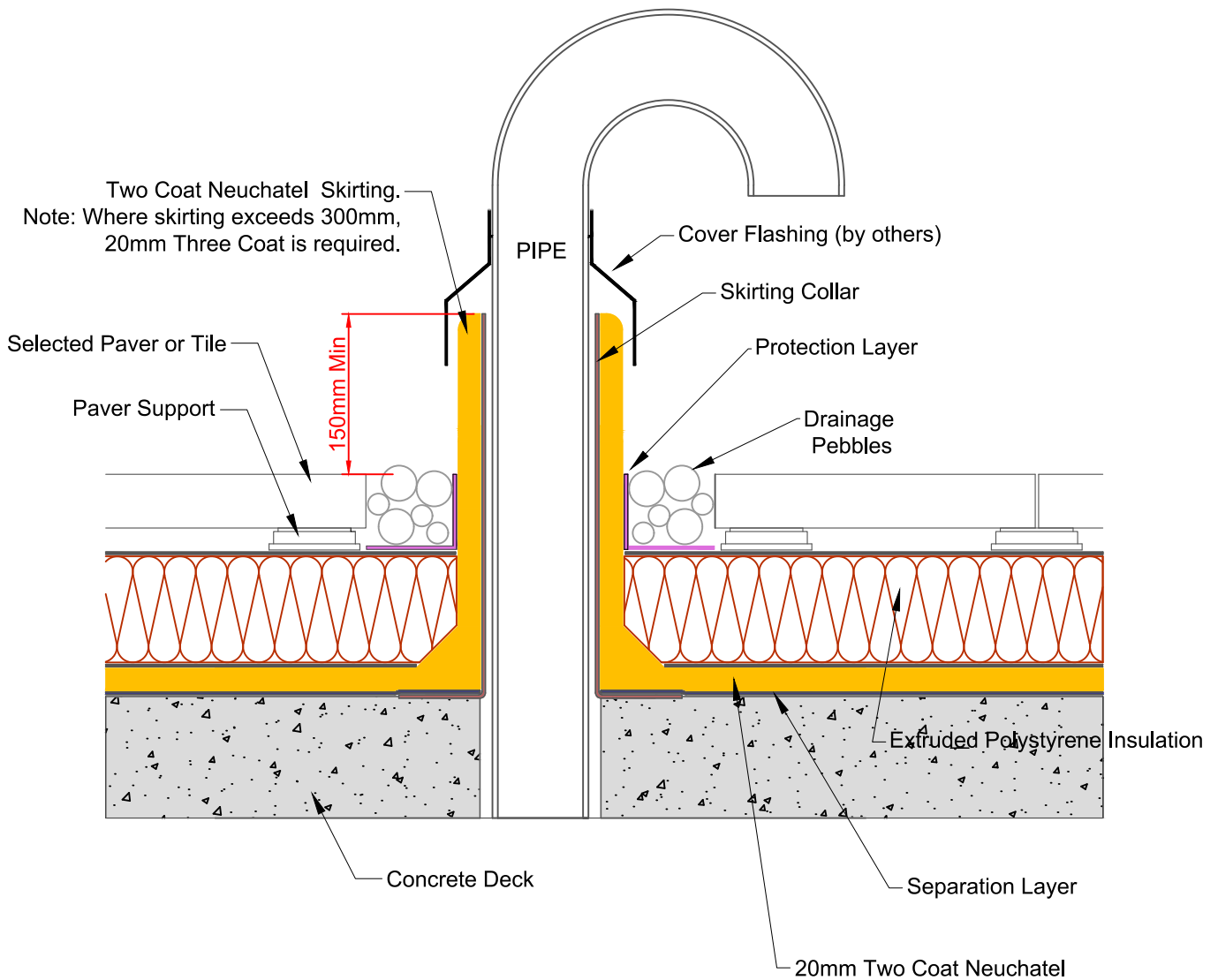

masterspec 4411AD

<p>TITLE: 'HOCKEY STICK' PIPE PENETRATION DETAIL INVERTED INSULATION DETAIL</p>		<p>www.neuchatel.co.nz TECHNICAL SERVICES. Tel: 09 441 4595 email: info@neuchatel.co.nz</p>
<p>Drawing: INV 011B Rev1</p>	<p>OCT 2023</p>	<p>Drawing is indicative only and subject to approval for use in the application required.</p>
	<p>Not to Scale</p>	