

Neuchâtel Podium System Standard Detail Drawings

Document Version: 001

Issue Date: October 2023



Index

Reference No.	Issue Date	Version No.	Description
POD 001	Oct 2023	Rev1	Upstand Detail Podium Detail
POD 001C	Oct 2023	Rev1	Timber Wall Junction Detail Podium Detail
POD 001D	Oct 2023	Rev1	Rendered Upstand Detail Podium Detail
POD 002	Oct 2023	Rev1	Torch-On Upstand Detail Podium Detail
POD 003	Oct 2023	Rev1	Cast Concrete Upstand Detail Podium Detail
POD 004	Oct 2023	Rev1	Threshold Upstand Detail - Flush Cill Podium Detail
POD 004B	Oct 2023	Rev1	Threshold Upstand Detail - Rebated Cill Podium Detail
POD 005	Oct 2023	Rev1	Parapet Outlet Detail Podium Detail
POD 005A	Oct 2023	Rev1	Scupper Outlet Detail PodiumDetail
POD 006	Oct 2023	Rev1	Outlet Detail Podium Detail
POD 006B	Oct 2023	Rev1	Channel Drain Detail Podium Detail
POS 007	Oct 2023	Rev1	Cast Concrete Parapet with Cap Flashing Detail
POD 008	Oct 2023	Rev1	Change of Level Detail Podium Detail
POD 009C	Oct 2023	Rev1	Typical Trimmed Edge Detail Podium Detail
POD 010	Oct 2023	Rev1	Gutter Drip Edge Detail Podium Detail
POD 011B	Oct 2023	Rev1	'Hockey Stick' Pipe Penetration Detail Podium Detail
POD 016	Oct 2023	Rev1	Pergola Support Detail Podium Detail



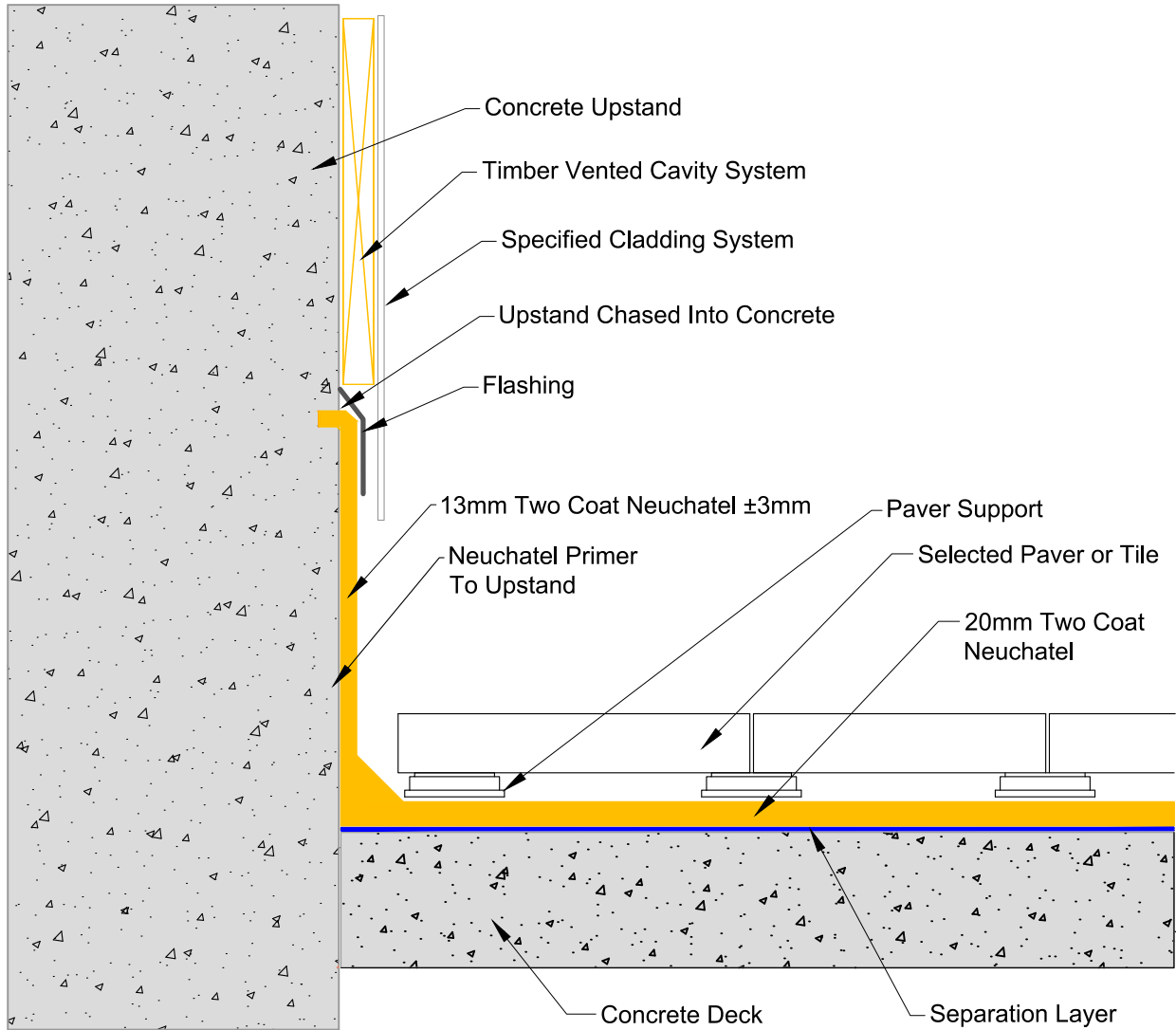

masterspec 4414AD

TITLE: **UPSTAND DETAIL
PODIUM DETAIL**

www.neuchatel.co.nz

TECHNICAL SERVICES.
Tel: 09 441 4595
email: info@neuchatel.co.nz

Drawing: **POD 001 Rev1**

OCT 2023

Not to Scale

Drawing is indicative only and subject to approval for use in the application required.

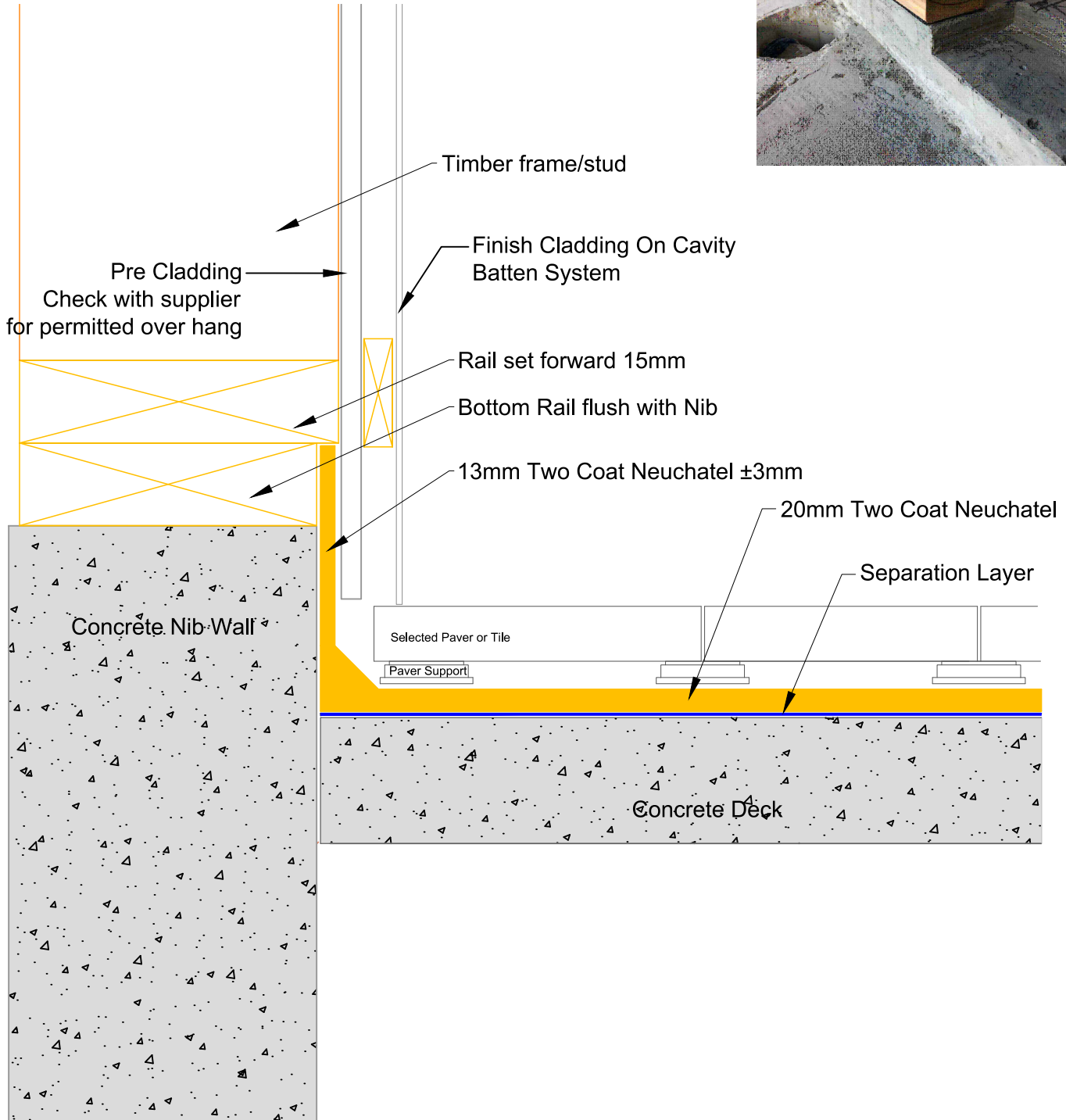

masterspec 4414AD

TITLE: **TIMBER WALL JUNCTION DETAIL**
PODIUM DETAIL

www.neuchatel.co.nz

TECHNICAL SERVICES.
Tel: 09 441 4595
email: info@neuchatel.co.nz

Drawing: POD 001C Rev1

OCT 2023

Not to Scale

Drawing is indicative only and subject to approval for use in the application required.

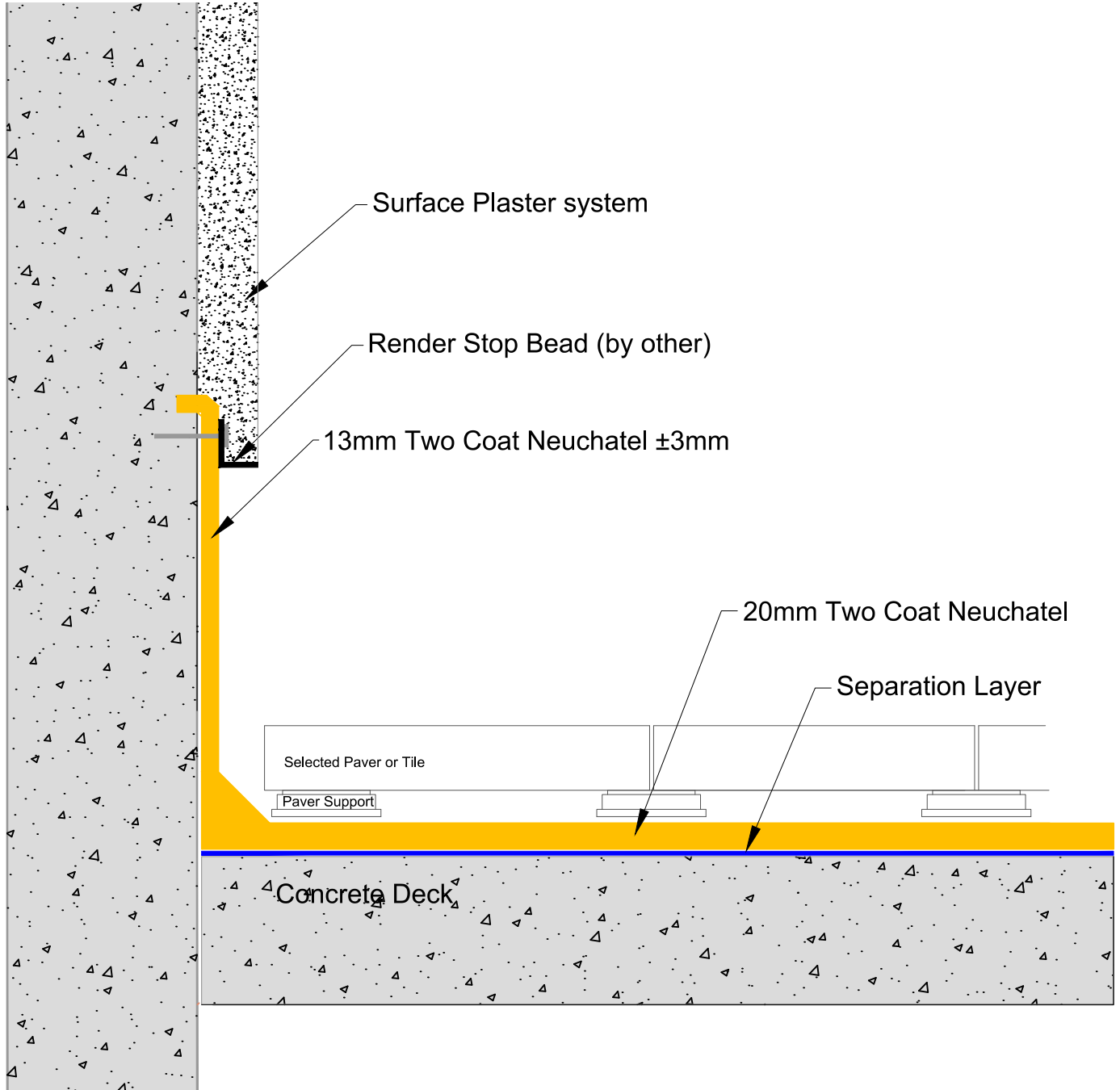

masterspec 4414AD

TITLE: RENDERED UPSTAND DETAIL PODIUM DETAIL		www.neuchatel.co.nz TECHNICAL SERVICES. Tel: 09 441 4595 email: info@neuchatel.co.nz
Drawing: POD 001D Rev1	OCT 2023 Not to Scale	Drawing is indicative only and subject to approval for use in the application required.

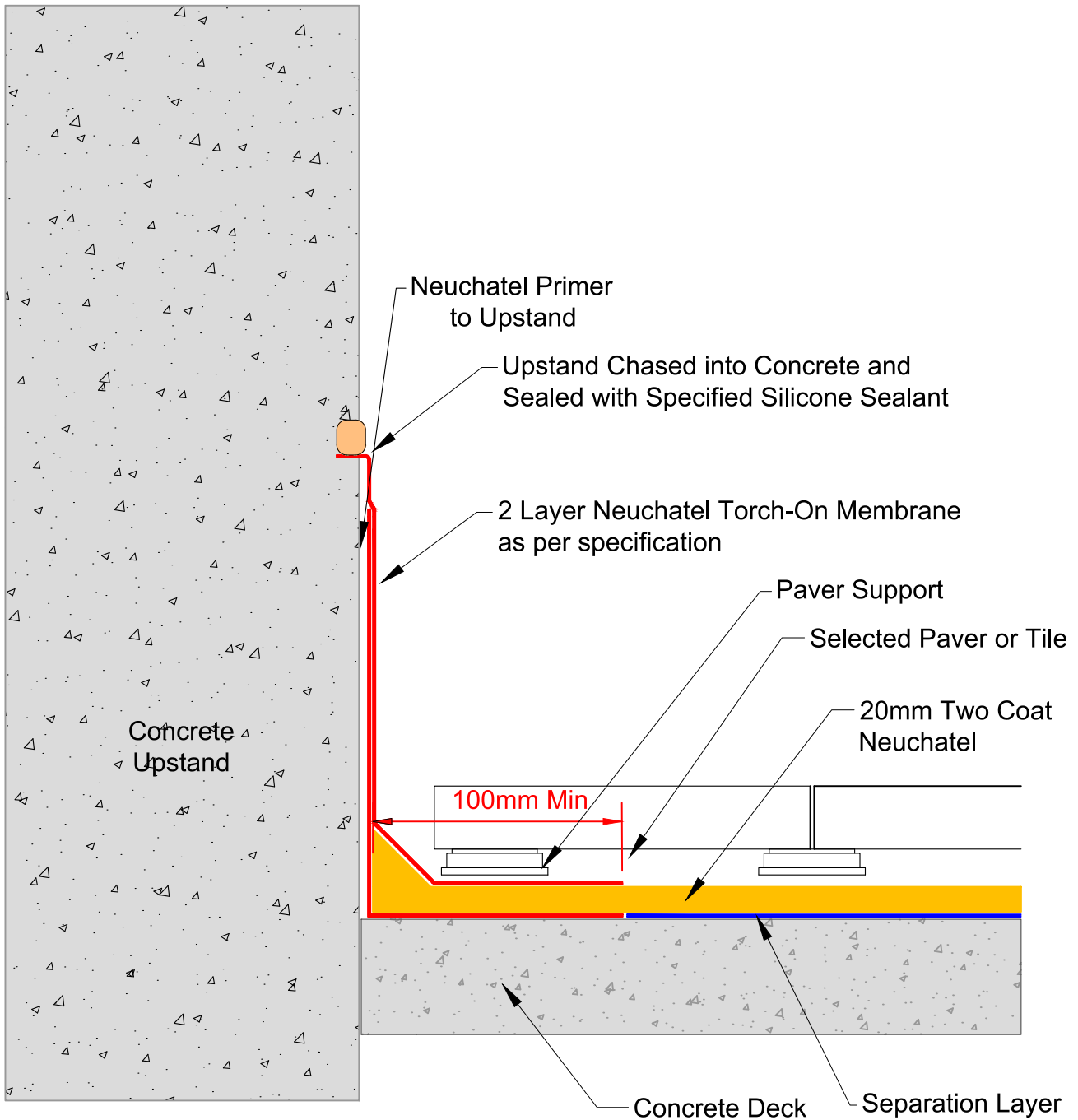

masterspec 4414AD

TITLE: **TORCH-ON UPSTAND DETAIL**
PODIUM DETAIL

www.neuchatel.co.nz
TECHNICAL SERVICES.
Tel: 09 441 4595
email: info@neuchatel.co.nz

Drawing: **POD 002 Rev1**

OCT 2023

Not to Scale

Drawing is indicative only and subject to approval for use in the application required.

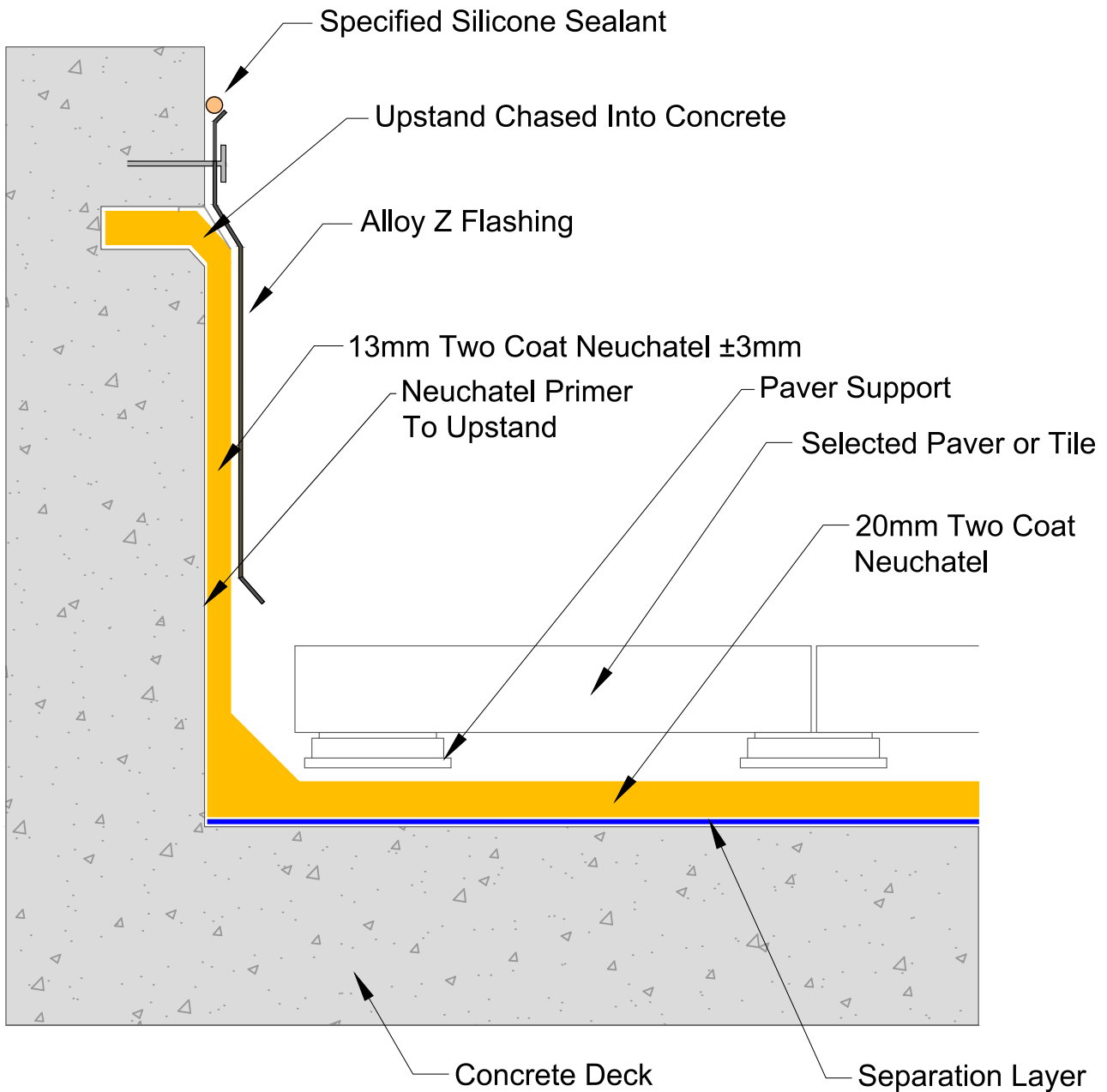

masterspec 4414AD

TITLE: **CAST CONCRETE UPSTAND DETAIL**
PODIUM DETAIL

www.neuchatel.co.nz
TECHNICAL SERVICES.
Tel: 09 441 4595
email: info@neuchatel.co.nz

Drawing: POD 003 Rev1

OCT 2023

Not to Scale

Drawing is indicative only and subject to approval for use in the application required.

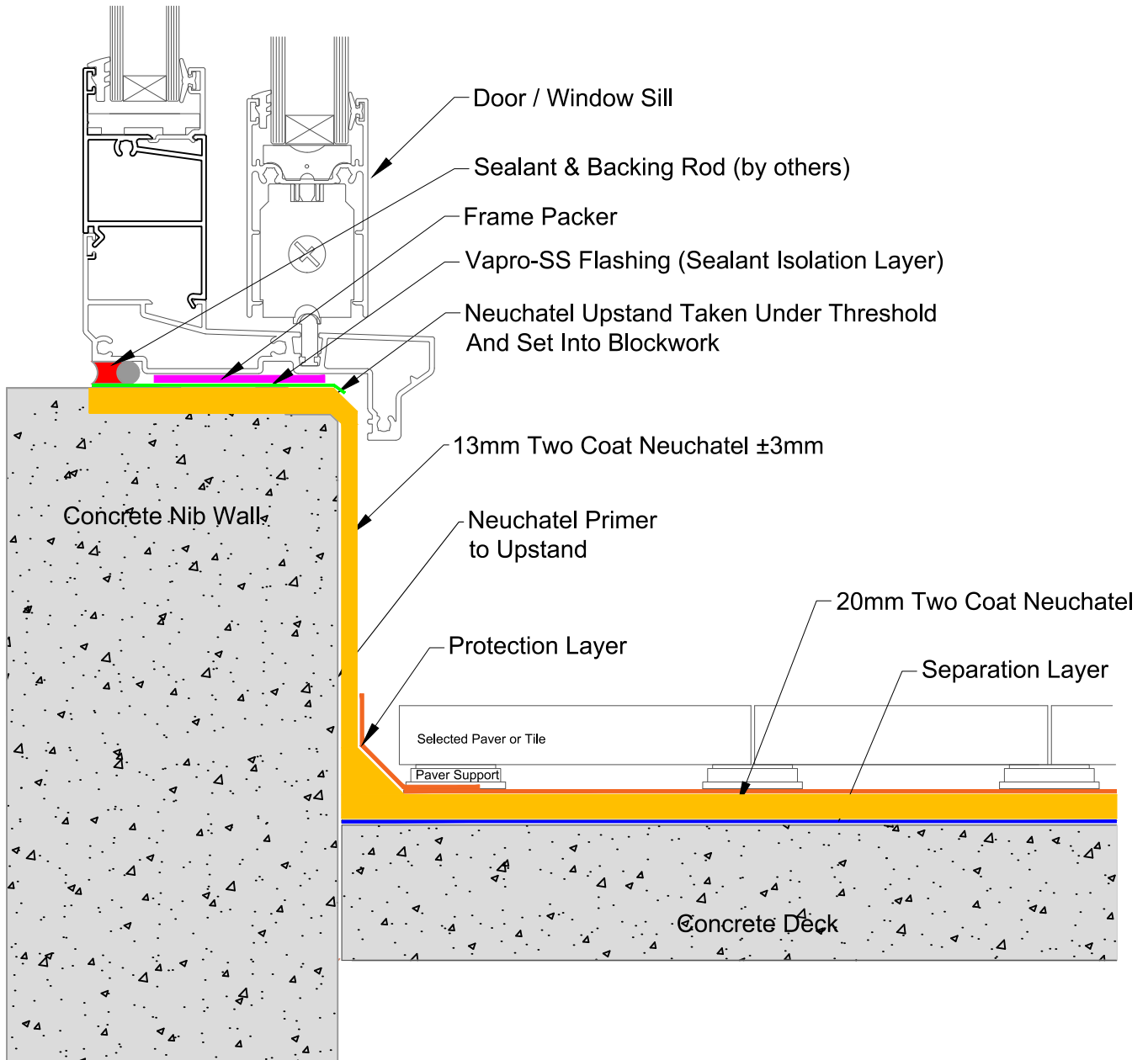

masterspec 4414AD

TITLE: THRESHOLD UPSTAND DETAIL - FLUSH CILL
PODIUM DETAIL

www.neuchatel.co.nz

TECHNICAL SERVICES.
Tel: 09 441 4595
email: info@neuchatel.co.nz

Drawing: POD 004 Rev1

OCT 2023

Not to Scale

Drawing is indicative only and subject to approval for use in the application required.

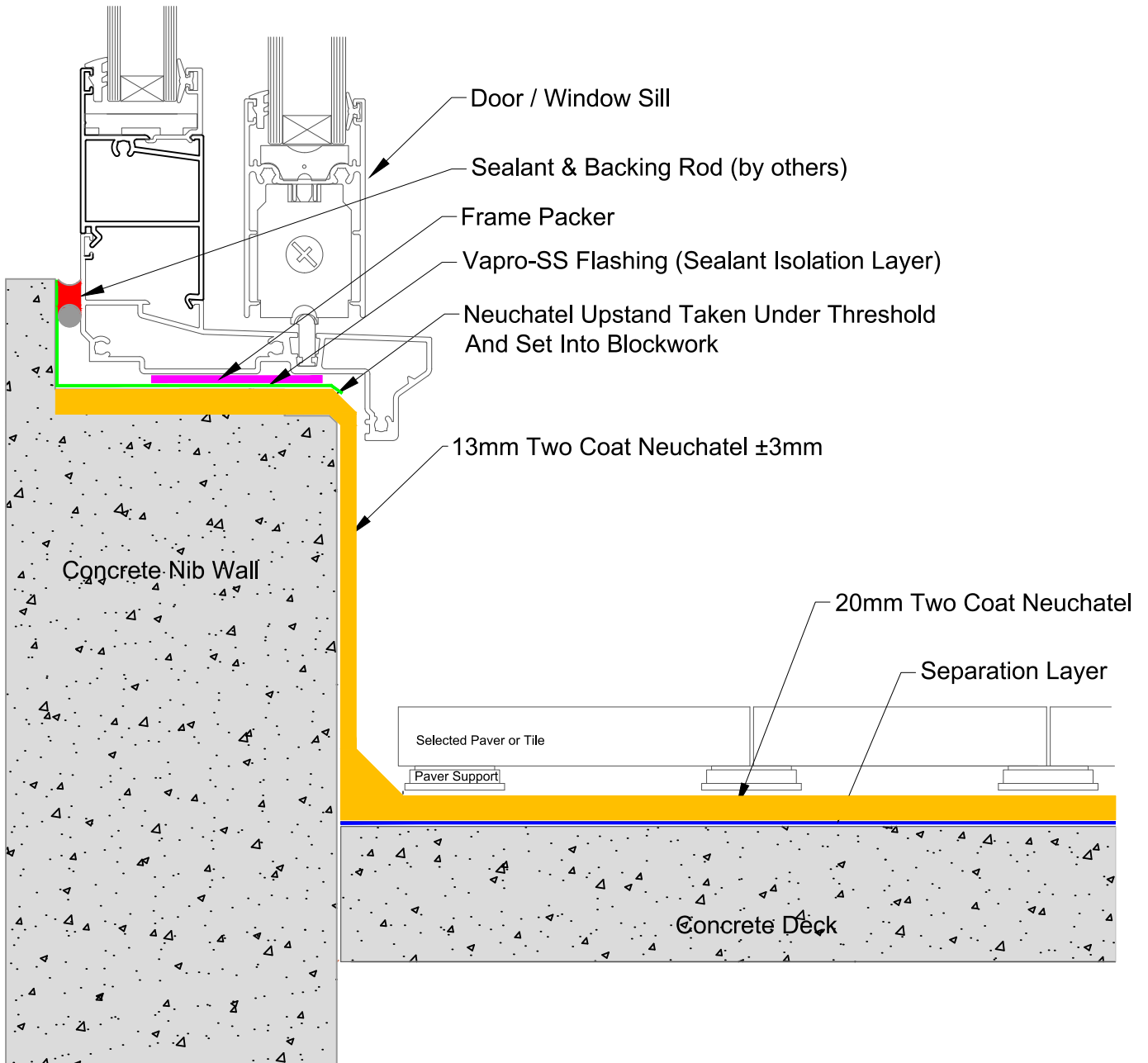

masterspec 4414AD

TITLE: **THRESHOLD UPSTAND DETAIL - REBATED CILL**
PODIUM DETAIL

www.neuchatel.co.nz
TECHNICAL SERVICES.
Tel: 09 441 4595
email: info@neuchatel.co.nz

Drawing: POD 004B Rev1

OCT 2023

Not to Scale

Drawing is indicative only and subject to approval for use in the application required.

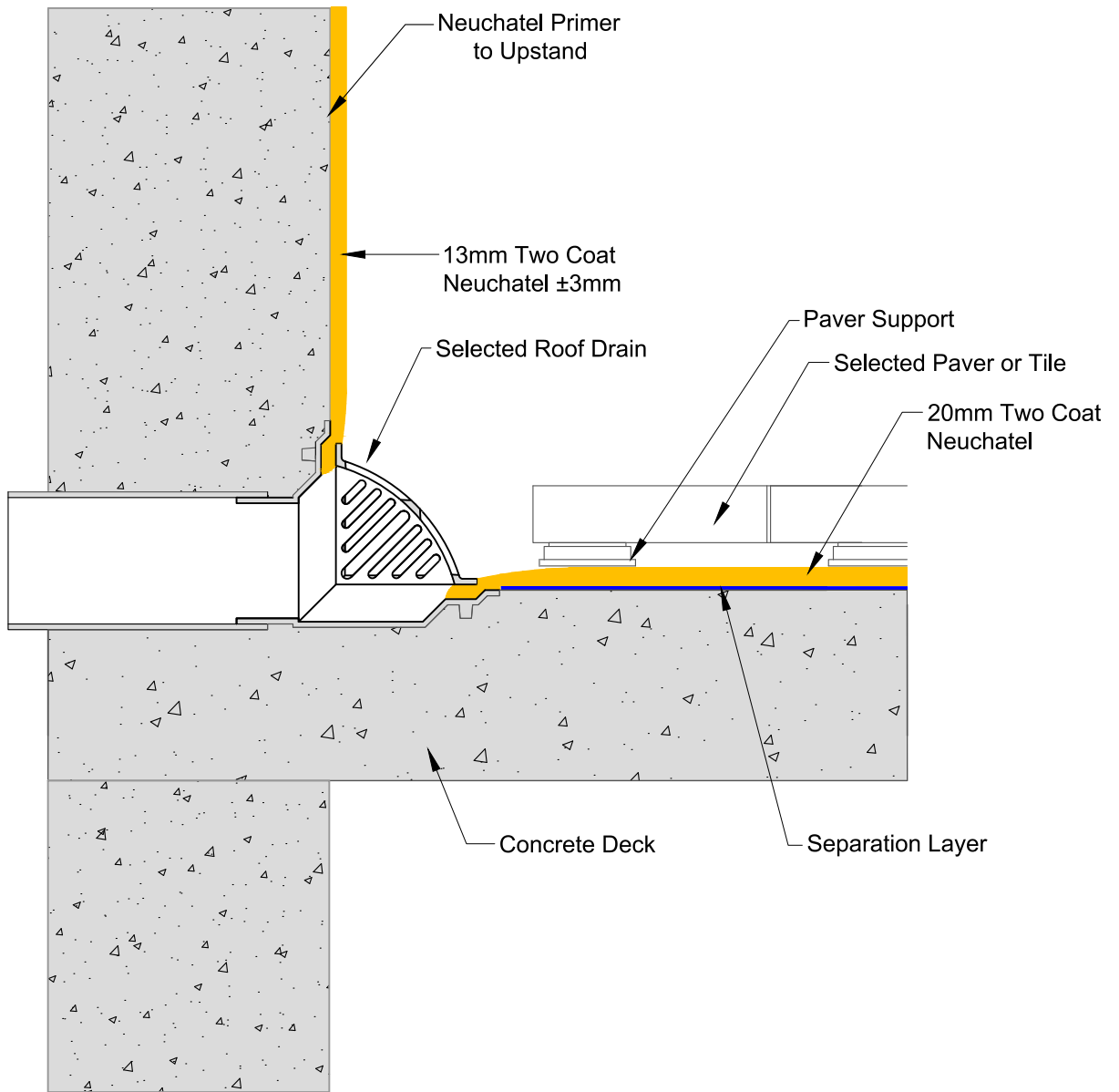

masterspec 4414AD

TITLE: PARAPET OUTLET DETAILPODIUM DETAIL		<p>www.neuchatel.co.nz TECHNICAL SERVICES. Tel: 09 441 4595 email: info@neuchatel.co.nz</p>
Drawing: POD 005 Rev1	OCT 2023	
	Not to Scale	Drawing is indicative only and subject to approval for use in the application required.

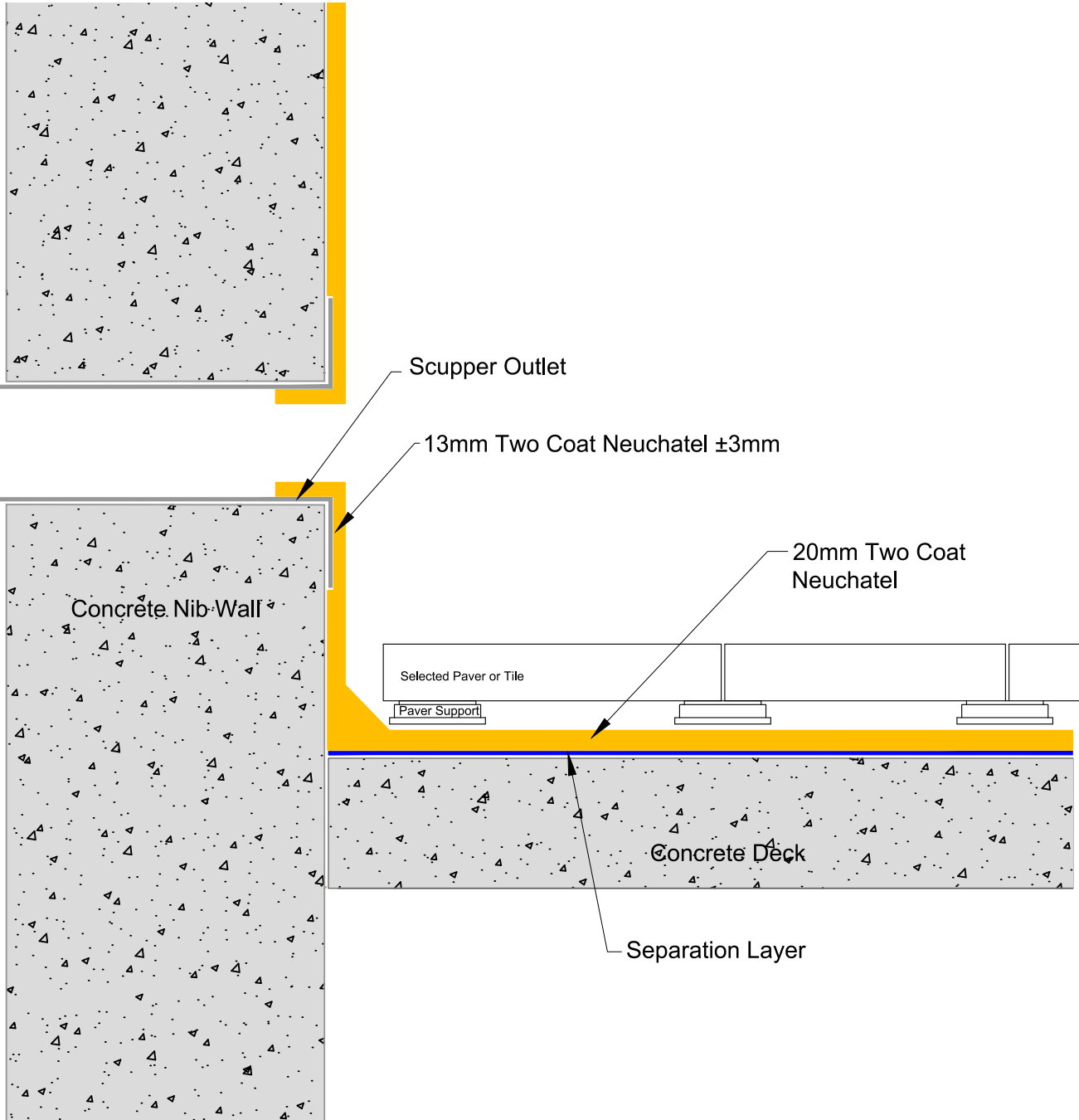

masterspec 4414AD

TITLE: **SCUPPER OUTLET DETAIL**
PODIUM DETAIL

www.neuchatel.co.nz

TECHNICAL SERVICES.
Tel: 09 441 4595
email: info@neuchatel.co.nz

Drawing: POD 005A Rev1

OCT 2023

Not to Scale

Drawing is indicative only and subject to approval for use in the application required.

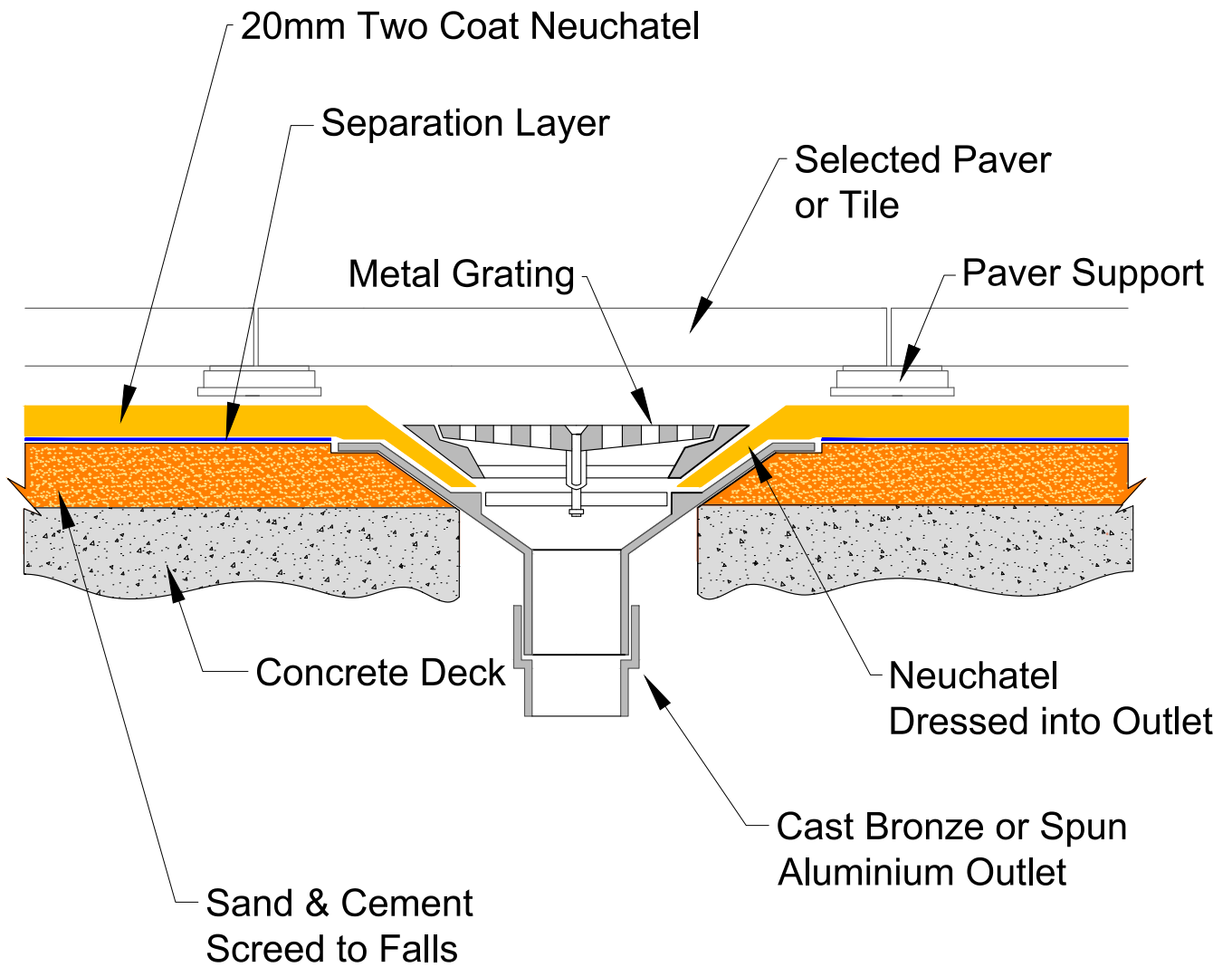

masterspec 4414AD

TITLE: **OUTLET DETAIL
PODIUM DETAIL**

www.neuchatel.co.nz

TECHNICAL SERVICES.
Tel: 09 441 4595
email: info@neuchatel.co.nz

Drawing: POD 006 Rev1

OCT 2023

Not to Scale

Drawing is indicative only and subject to approval for use in the application required.

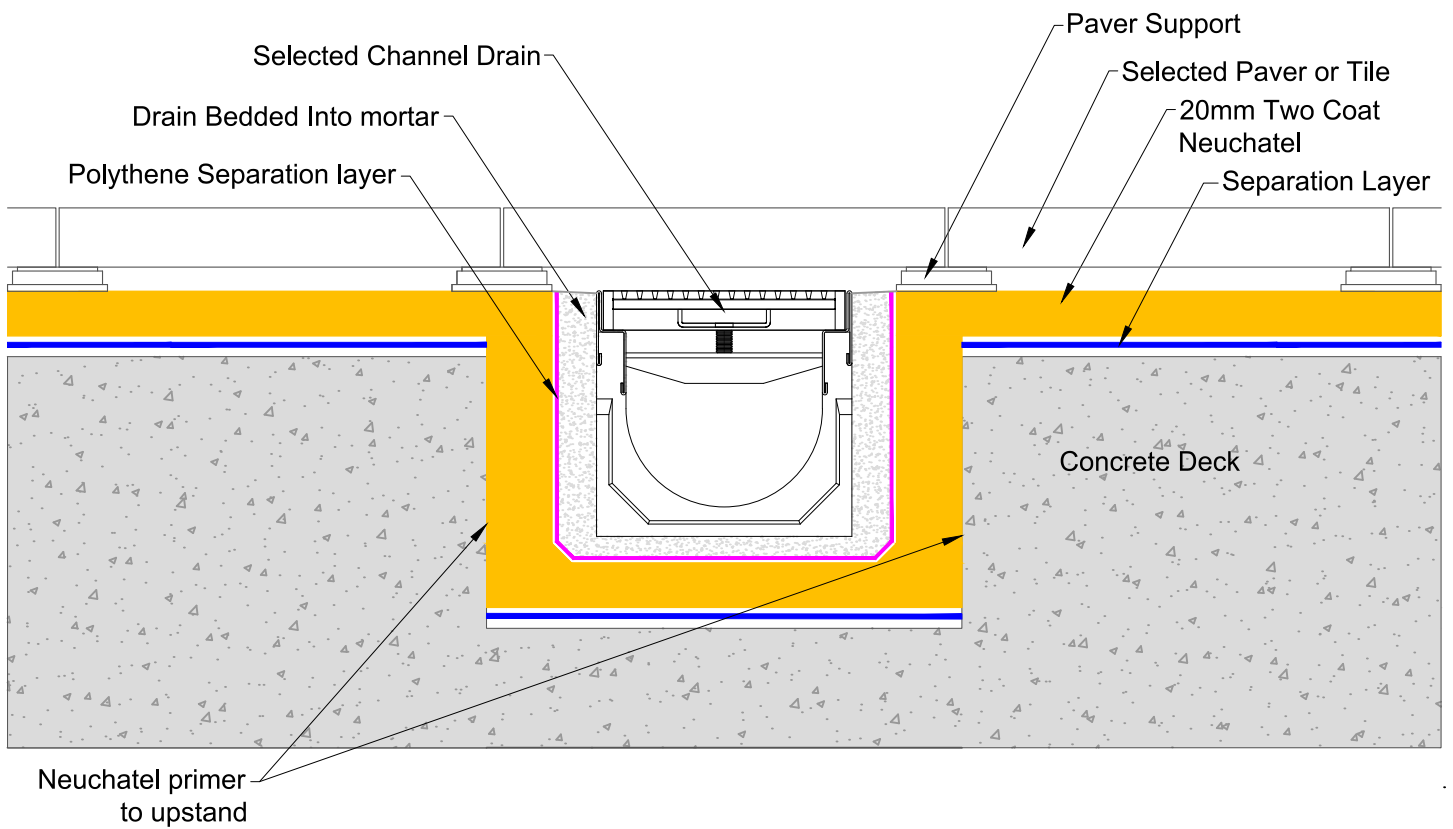

masterspec 4414AD

<p>TITLE: CHANNEL DRAIN DETAIL PODIUM DETAIL</p>	<p>www.neuchatel.co.nz TECHNICAL SERVICES. Tel: 09 441 4595 email: info@neuchatel.co.nz</p>	
<p>Drawing: POD 006B Rev1</p>	<p>OCT 2023 Not to Scale</p>	<p>Drawing is indicative only and subject to approval for use in the application required.</p>

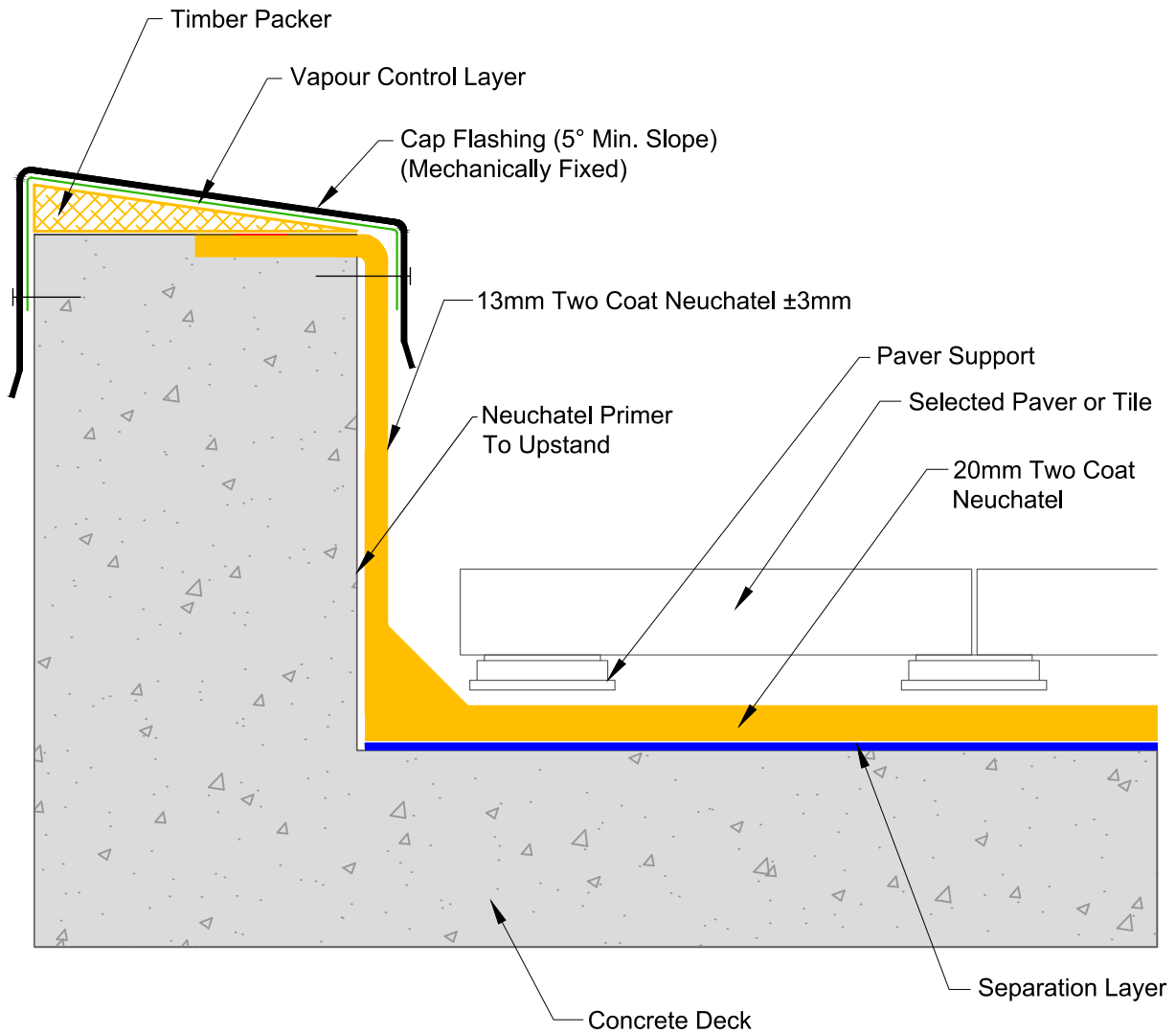

masterspec 4414AD

TITLE: **CAST CONCRETE PARAPET WITH CAP FLASHING
DETAIL
PODIUM DETAIL**

www.neuchatel.co.nz
TECHNICAL SERVICES.
Tel: 09 441 4595
email: info@neuchatel.co.nz

Drawing: **POD 007 Rev1** **OCT 2023**
Not to Scale

Drawing is indicative only and subject to approval for use in the application required.

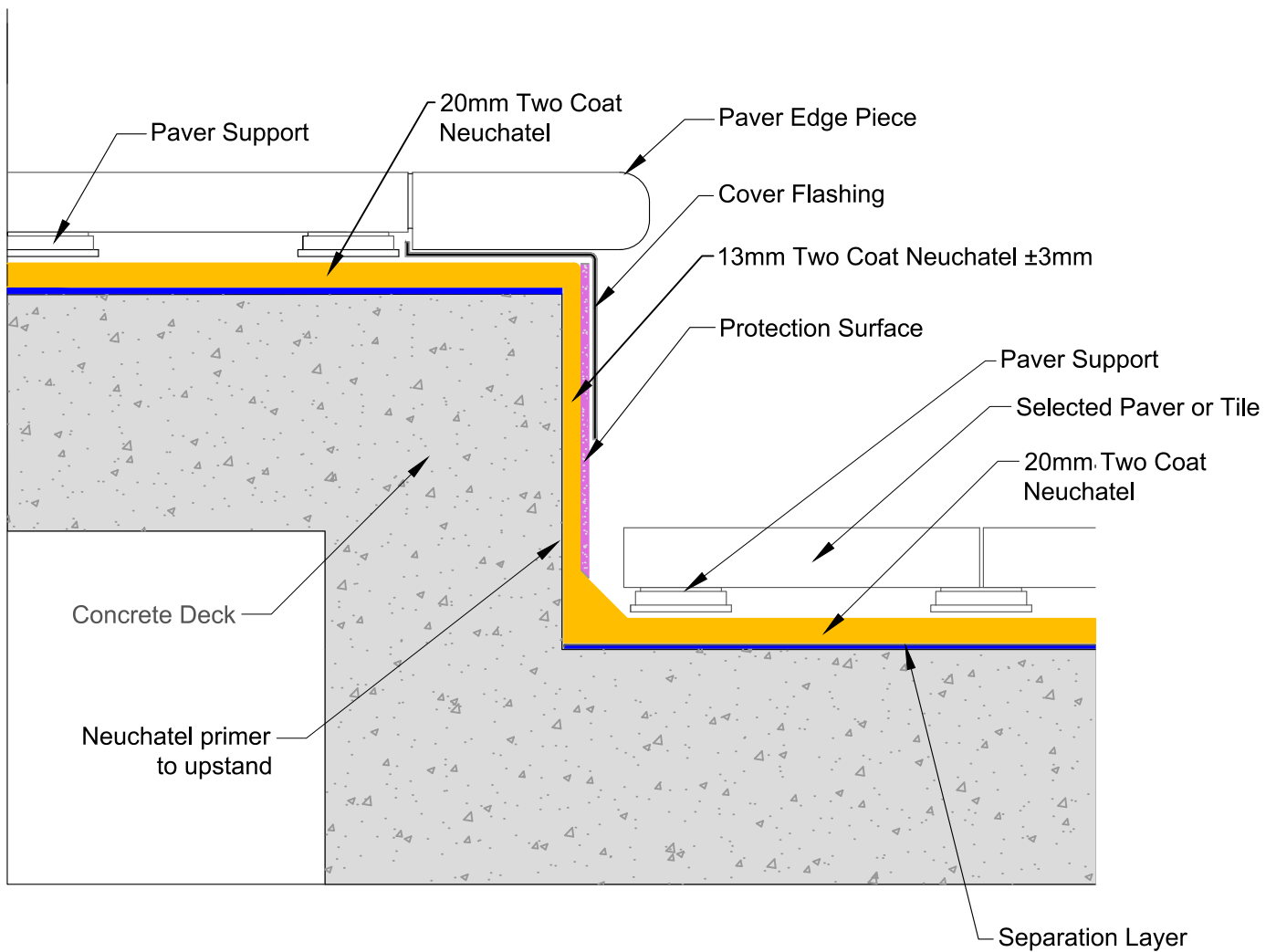

masterspec 4414AD

TITLE: **CHANGE OF LEVEL DETAIL
PODIUM DETAIL**

www.neuchatel.co.nz

TECHNICAL SERVICES.
Tel: 09 441 4595
email: info@neuchatel.co.nz

Drawing: **POD 008 Rev1**

OCT 2023

Not to Scale

Drawing is indicative only and subject to approval for use in the application required.

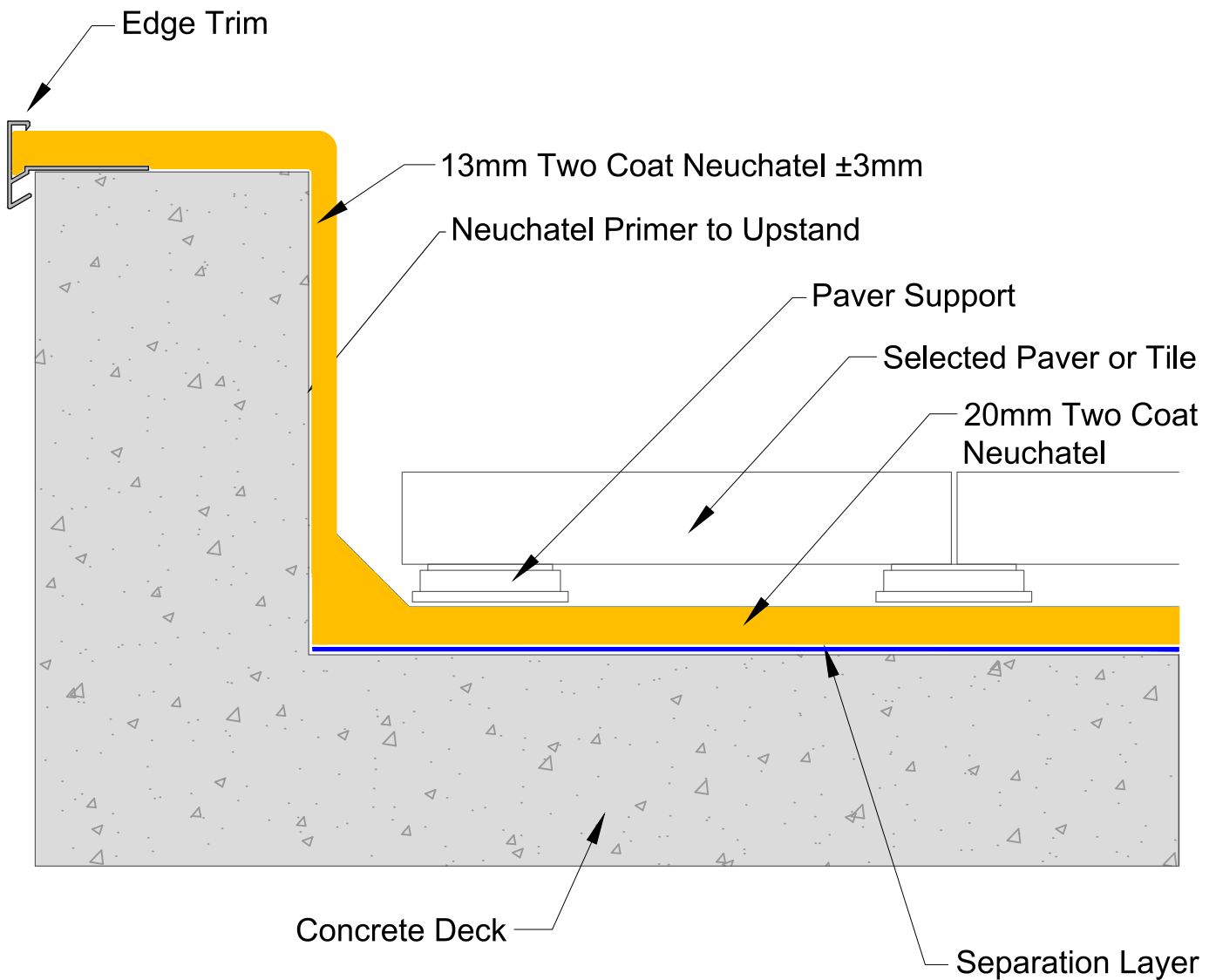

masterspec 4414AD

TITLE: TYPICAL TRIMMED EDGE DETAIL
PODIUM DETAIL

www.neuchatel.co.nz
TECHNICAL SERVICES.
Tel: 09 441 4595
email: info@neuchatel.co.nz

Drawing: POD 009C Rev1

OCT 2023

Not to Scale

Drawing is indicative only and subject to approval for use in the application required.

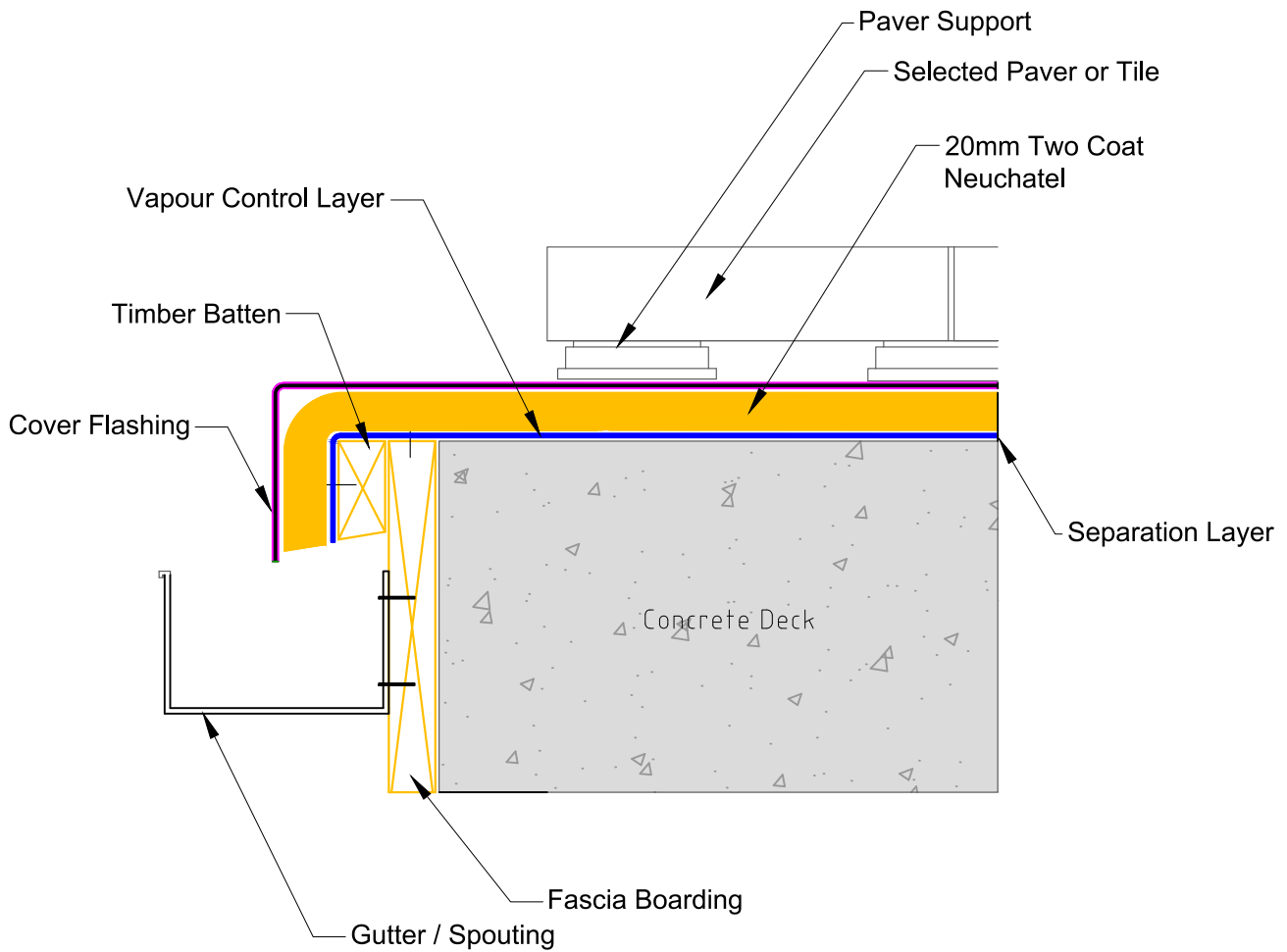

masterspec 4414AD

<p>TITLE: GUTTER DRIP EDGE DETAIL PODIUM DETAIL</p>	<p>www.neuchatel.co.nz TECHNICAL SERVICES. Tel: 09 441 4595 email: info@neuchatel.co.nz</p>	
<p>Drawing: POD 010 Rev1</p>	<p>OCT 2023 Not to Scale</p>	<p>Drawing is indicative only and subject to approval for use in the application required.</p>

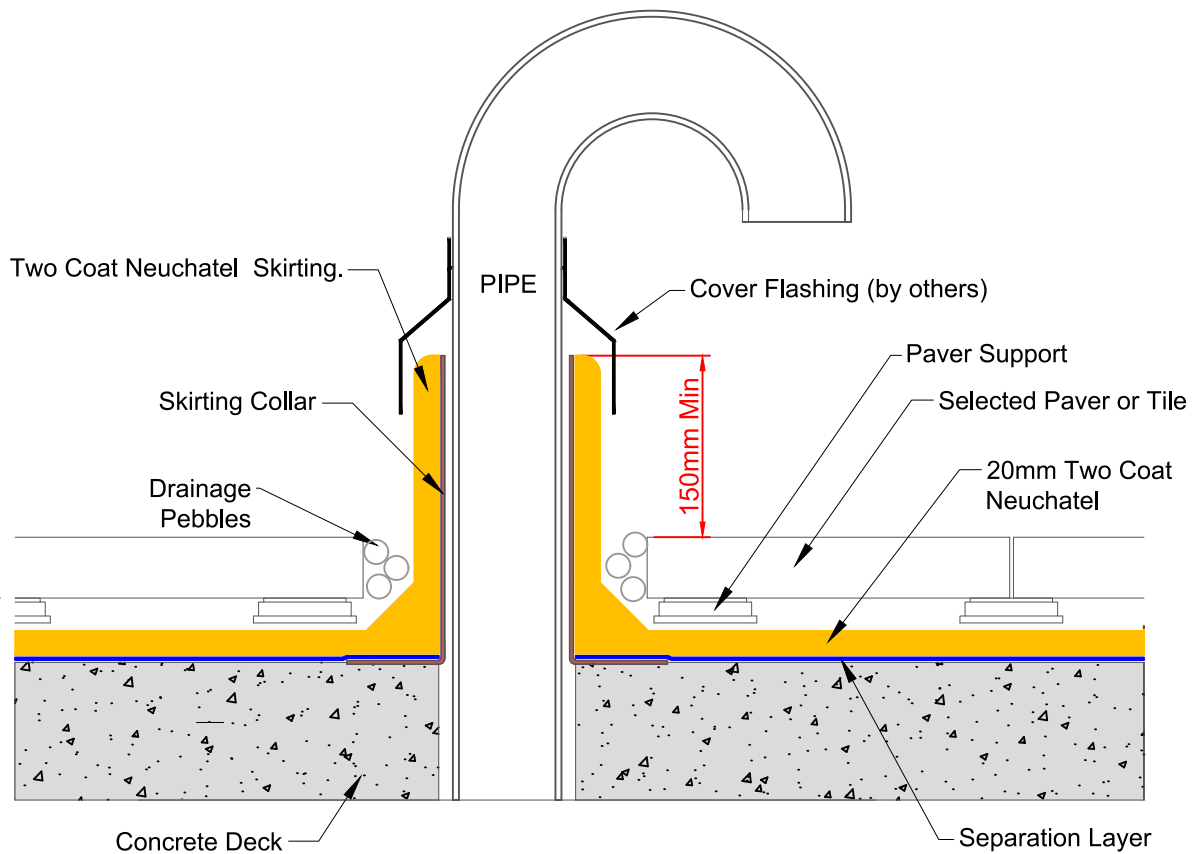

masterspec 4414AD

TITLE: 'HOCKEY STICK' PIPE PENETRATION
DETAILPODIUM DETAIL

www.neuchatel.co.nz

TECHNICAL SERVICES.
Tel: 09 441 4595
email: info@neuchatel.co.nz

Drawing: POD 011B Rev1

OCT 2023

Not to Scale

Drawing is indicative only and subject to approval for use in the application required.

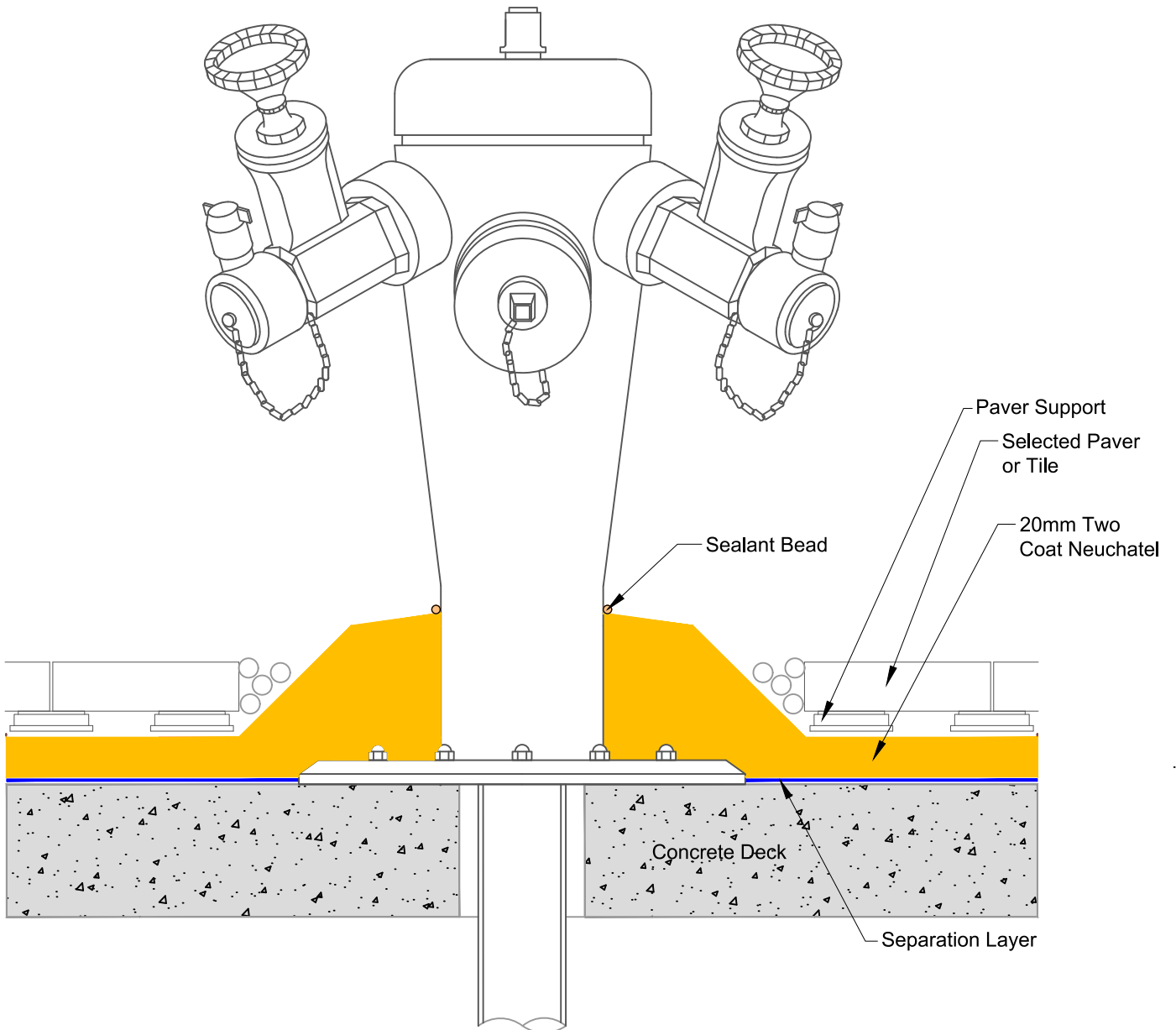

masterspec 4414AD

TITLE: 'HOCKEY STICK' PIPE PENETRATION
DETAILPODIUM DETAIL

www.neuchatel.co.nz

TECHNICAL SERVICES.
Tel: 09 441 4595
email: info@neuchatel.co.nz

Drawing: POD 011B Rev1

OCT 2023

Not to Scale

Drawing is indicative only and subject to approval for use in the application required.

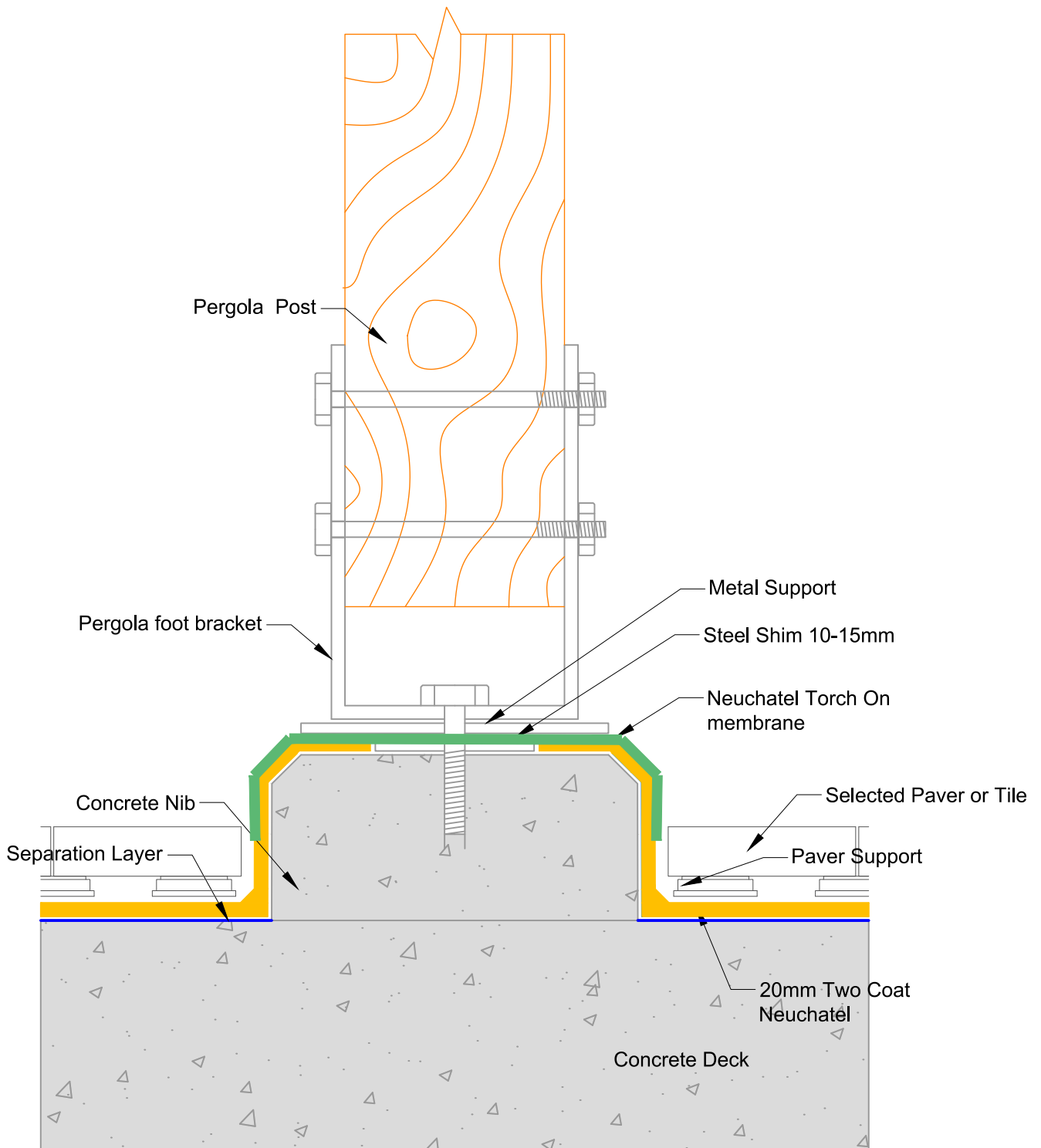

masterspec 4414AD

TITLE: **PERGOLA SUPPORT DETAIL
PODIUM DETAIL**

www.neuchatel.co.nz

TECHNICAL SERVICES.
Tel: 09 441 4595
email: info@neuchatel.co.nz

Drawing: **POD 016 Rev1**

OCT 2023

Not to Scale

Drawing is indicative only and subject to approval for use in the application required.